

XMR401AHD

Mobile Digital Video Recorder



Main Features

- Supports 4 channels AHD+1 channel 720P
- Supports dual SD cards for main recording
- Supports GPS for location tracking
- Supports WIFI for video files download
- Built-in 3G/4G for live view and remote management
- Supports 360 degree anti-vibration
- Supports USB2.0 high speed backup
- Supports data recovery technology

Overview

XMR-401AHD is a functional Mobile Digital Video Recorder specially designed for vehicle video surveillance and remote monitoring. It has a high-speed processor and embedded operating system, combining with the most advanced H.264 video compression / decompression technology, network, as well as GPS positioning technology. It supports not only video recording in 720P, AHD, WD1, HD1 and CIF formats, but also vehicle travel information recording and wireless data upload. It is powerful with modular design, flexible installation, easy maintenance and high reliability.

Specification

Function Overview		Preview, Recording, Playback, Network, Locating
System	OS	Linux 3.0.8
	Control Mode	Easy Check, network (3G/4G/WIFI), mouse, CP4
Video	Input	4 channels AHD+1 channel 720P
	Output	1 channel
	Total Resource	PAL: (4x25)FPS WD1+30FPS 720P(IPC) or (4x12)FPS 720P(AHD)+30FPS 720P(IPC) NTSC: (4x30)FPS WD1 +30FPS 720P or (4x15)FPS 720P(AHD)+30FPS 720P(IPC)
	Video Signal Standard	Electrical level: 1Vpp Impedance : 75Ω NTSC/PAL Optional
Audio	Input	5channels (1 channel IPC audio input)
	Output	1channel
	Audio Signal Standard	Electrical level: 2Vpp Input impedance: 4.7kΩ
Display	Display Split	1/4
	OSD	GPS information, alarm, vehicle No., speed, date/time
	Operation Interface	Semi-transparent GUI
Recording	Video/Audio Compression	Video: H.264
		Audio: ADPCM, G.711A, G.711U
	Image Resolution	Analog: PAL: 720P(1280X720), WD1(928X576), WHD1(928X288), WCIF(464X288), D1(704X576), HD1(704x288), CIF(352x288); NTSC: 720P(1280X720), WD1(928X480), WHD1(928X240), WCIF(464X240), D1(704x480), HD1(704x240), CIF(352x240); Digital: 720P(1280X720);
	Image Quality	1-8 levels adjustable (1 is the best)
	Recording Mode	Boot up/Manual/Schedule/Alarm
	Pre-recording	0-60minutes
	Post-recording	0-30 minutes
	Mirror/Dual Recording	Support
Playback	Playback Channel	1 channel by local playback
	Search Mode	Date/time, channel, event

Network	WiFi/3G/4G(Optional)	802.11b/g/n/EVDO/WCDMA/TDD-LTE/FDD-LTE
	IPC Ethernet	6-pin M12(10/100M x 1, PON power supply)
Locating	GPS	Location tracking, speed detection and time sync
Storage	SD Card	SD card x 2
Interface	USB	USB2.0 x 1
	SIM	SIM slot x 1
	RS232	RS232 x 1
	Sensor	8 inputs, 2 outputs
	Speed	1 channel pulse speed detection
	Intercommunication	I mic interface
	Interface	Touch panel CP4 Optional
Power	Input	DC8-36V, ACC
	Output	5V@500mA
	Max Power Consumption	29W
	Standby Power Consumption	≈0W

Dimension (mm)

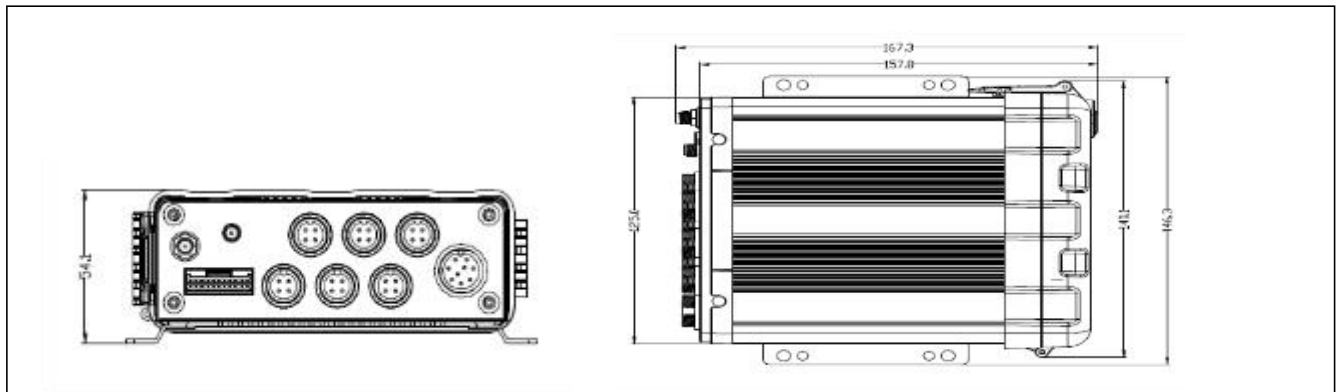



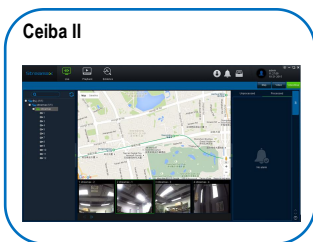

Physical Characteristic	Dimension (L × W × H)	167.3 x 146.3 x 54.1mm
	Weight	0.83Kg
Environment	Operating Temperature	-40°C- +70°C(With heater) or -10°C- +70°C
	Operating Relative Humidity	8%-90% (No Condense)

PC Software

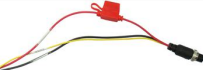

Standard accessories

Accessories	Description	Quantity	Accessories	Description	Quantity
	Vehicle fuses (7.5A and 15A)	2		Remote controller	1
	9 pin aviation power input wire	1		Screws	6
	MDVR key	1			

Optional accessories

Accessories	Description	Accessories	Description
	UPS3.0		Card reader
	Inertia sensor		LED panel
	Easy Check		Multi-functional displayer CP4
	6pin aviation head transforming to RJ45		On - Board Diagnostics
	Fire proof box		Serial alarm wire
	Back cover		Serial expansion box
	Video transforming wire		Serial transforming wire
	Amplifier&speaker transforming wire		GPS module and Antenna
	Disk reader		Built in 3G/4G module and Antenna
	Built-in WIFI module and Antenna		