

INSTALLATION INSTRUCTIONS FOR DCP-SOM-AI, DCP-SOM-A CLASS A SUPERVISED OUTPUT MODULE

The information contained in this installation instruction is a quick reference guide. For detailed system information refer to the panel manufacturer's installation manual. This instruction will not address specific programming procedure.

GENERAL DESCRIPTION

This instruction applies to the Class A Supervised Output Module (SOM-A and SOM-AI) which is to be connected to a DCP compatible Signaling Line Circuit (SLC). Typical applications are to provide supervised 24VDC power to operate audible and visual fire alarm indicating devices such as horns, bells and strobes etc. Notification device output provides supervision for open and short circuit conditions. Uses auxiliary power input for device operation and for powering signaling devices.

MOUNTING REQUIREMENTS

The DCP-SOM-A Supervised Output Module is mounted as shown in Figures 2 on page 2 of this instruction.

WIRING

NOTE: All wiring must conform to local codes, ordinances and regulations

- 1) Install module wiring in accordance with the job drawings and appropriate wiring diagram (see Fig. 3 and 4).
- 2) Secure the module to a U.L. listed electrical box (supplied by installer), as shown in Figures 2.
- 3) The address must be set on the module before cover plate is attached (see Figure 1).

CAUTION !!!
TO ENSURE PROPER OPERATION CONNECT THIS MODULE TO A COMPATIBLE FIRE CONTROL PANEL ONLY. REFER TO PANEL INSTRUCTIONS FOR PROPER CONNECTION AND COMPATIBILITY.

CAUTION !!!
IF THIS MODULE WILL BE INSTALLED IN AN EXISTING OPERATIONAL SYSTEM, INFORM THE OPERATOR AND LOCAL AUTHORITY THAT THE SYSTEM WILL BE TEMPORARILY OUT OF SERVICE. DISCONNECT POWER TO THE CONTROL PANEL BEFORE INSTALLING THE MODULE.

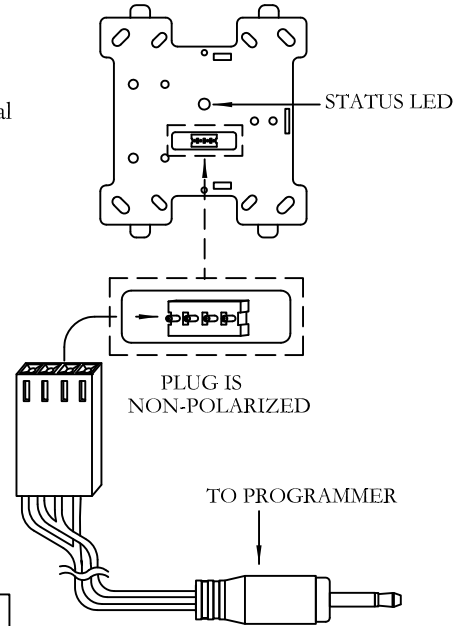

FIGURE 1.
EXPLODED VIEW OF ADDRESS PROGRAMMING-PLUG AND CONNECTOR

NOTE: When installing fire alarm system devices, avoid placing devices or wiring close to potential **Radio Frequency** or **Electro-Magnetic** sources. Avoid running SLC circuit in the same conduit as power lines. Utilize twisted pair and shielded wire in environments where excessive noise is expected.

SPECIFICATIONS	
SLC Applied Voltage	Rated Range 25.3 ~ 39 VDC
SLC Current Consumption	Maximum 6mA: Red Alarm Light On Nominal SOM-AI: 420µA (Typical), SOM-A 220µA (Typical)
Auxiliary Applied Voltage	Rated 24VDC
24VDC Auxiliary Current Consumption	50µA (Typical)
Maximum Output Current (OUT+/OUT-, IN+/IN-)	2A @ 24VDC
EOL Device for OUT+ & OUT-	HOCHIKI AMERICA CORP. EOL Part NO. 0400-01046 10KΩ, 1/4W, 1/4inch
SCI On Resistance	60mΩ Maximum (Normal Condition)
SCI Fault Detection Threshold	12 Volts (Typical)
SCI Isolation Current (Short Circuit Condition)	10mA (Typical)
Maximum Quantity Per Loop	127
Visual Indicator (Status LED)	bi-color LED - Green & Red Color & Mode - Selected and Programmed by Control Panel's software
Operating Temperature Range	0°C (32°F) ~ 49°C (120°F)
Storage Temperature	-30°C (-22°F) ~ 70°C (158°F)
Max. Relative Humidity	Up to 90% RH Non-condensing
Environment	Indoor dry use only
Dimensions	4.2"W X 4.7"H X .85"D
Weight	Aproximately 3.0 ounces

MODELS

Class A SOM has two versions, DCP-SOM-A module and DCP-SOM-AI module. The SOM-AI version has a built-in SCI Short Circuit Isolator circuitry.

Module	Feature	SLC Loop Connectors
DCP-SOM-AI	Integrated SCI	IN_S+, IN_S-; OUT_S+, OUT_SC-
DCP-SOM-A	No SCI	S+, SC-

INTEGRATED SCI SHORT CIRCUIT ISOLATOR OPERATION

The DCP-SOM-AI has a built-in integrated SCI circuitry. In the event of a short on the S-SC line, the SCI circuit will activate and its Yellow LED indicator will be turned on steady and the SOM-AI module will report the short circuit condition to the Fire Control Panel.

The SCI has a fast response time but the Control Panel will detect a momentarily short before the SCI circuit breaks open if the short occurs during normal operation. However, if the S-SC line was short before power-on, the Control Panel will only detect an open loop because the SCI switch circuit never closes. In that case, it will rely on the SOM-AI to report a short.

The SCI circuit will prevent entire loop failure in case of a short. Upon removal of the short condition, the SCI will automatically restore the entire loop to normal operating state.

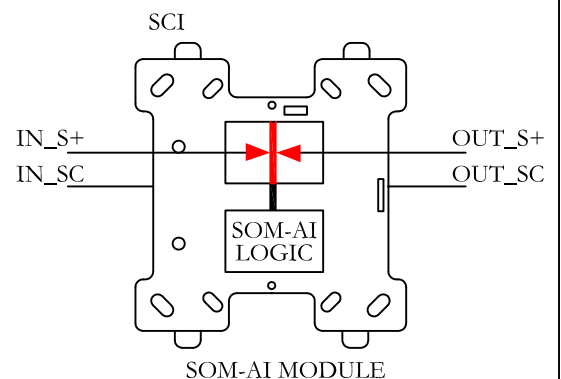

NOTE: An average of 6.75mA (communication current) per loop of SLC devices, must be factored into the panel battery backup calculations.

NOTE: NAC Installation wiring shall not exceed 2 ohms (14-18 AWG)

Note: SLC circuit is in reference to S, and SC

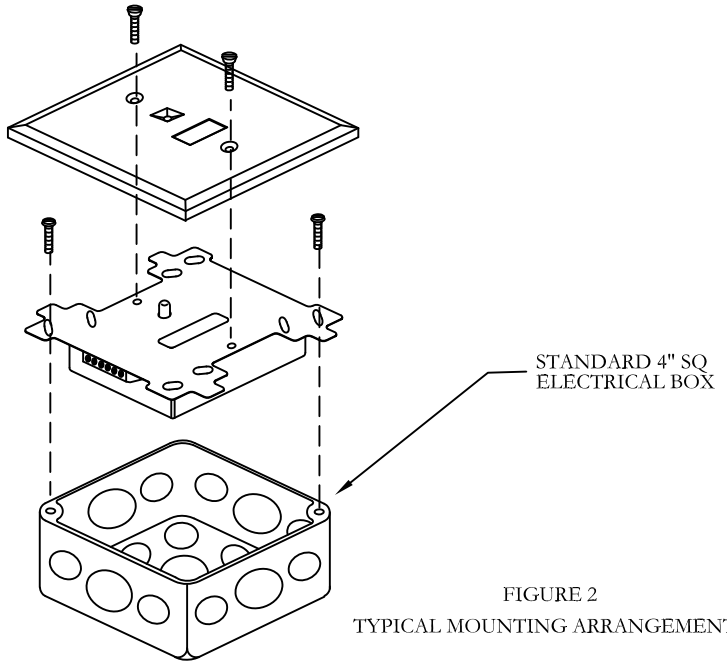

FIGURE 2
TYPICAL MOUNTING ARRANGEMENT

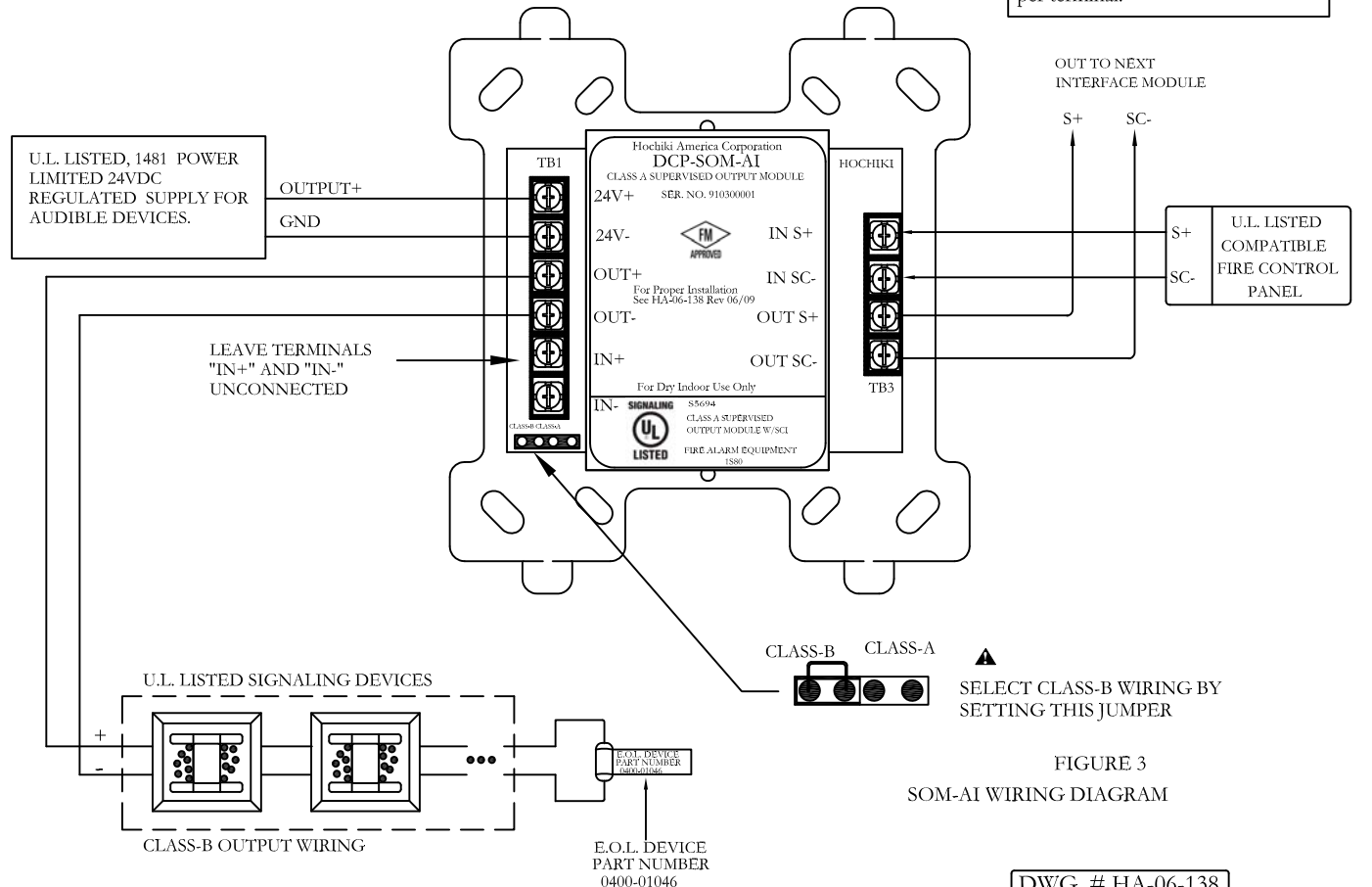
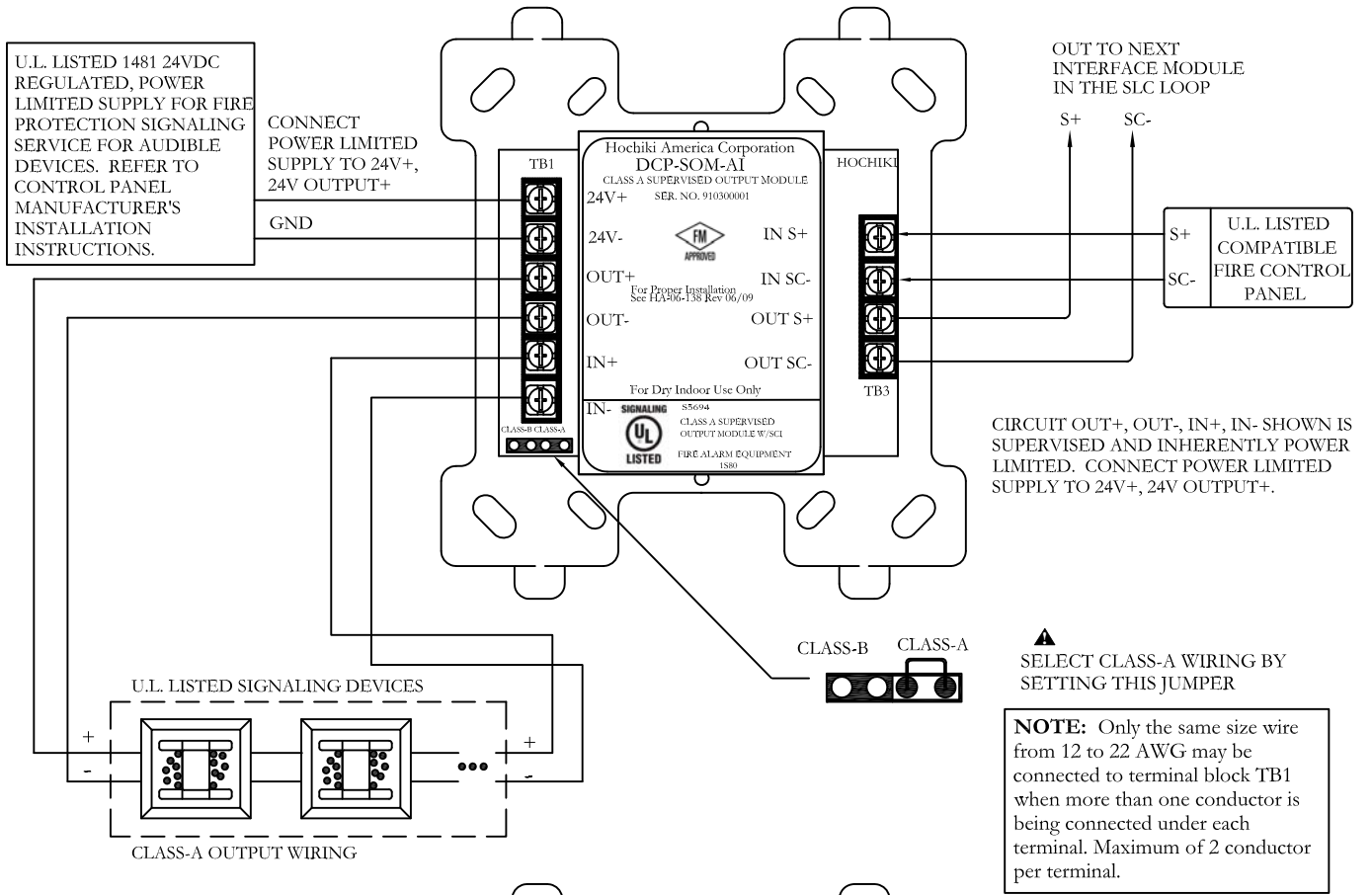

FIGURE 3
SOM-AI WIRING DIAGRAM

U.L. LISTED 1481 24VDC REGULATED, POWER LIMITED SUPPLY FOR FIRE PROTECTION SIGNALING SERVICE FOR AUDIBLE DEVICES. REFER TO CONTROL PANEL MANUFACTURER'S INSTALLATION INSTRUCTIONS.

CONNECT POWER LIMITED SUPPLY TO 24V+, 24V OUTPUT+
GND

OUT TO NEXT INTERFACE MODULE IN THE SLC LOOP
S+ SC-

U.L. LISTED COMPATIBLE FIRE CONTROL PANEL
S+ SC-

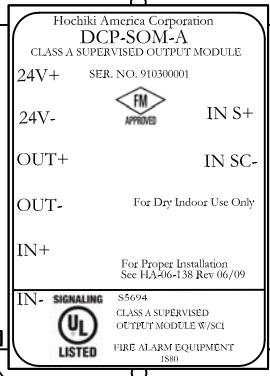

CIRCUIT OUT+, OUT-, IN+, IN- SHOWN IS SUPERVISED AND INHERENTLY POWER LIMITED. CONNECT POWER LIMITED SUPPLY TO 24V+, 24V OUTPUT+.

U.L. LISTED SIGNALING DEVICES

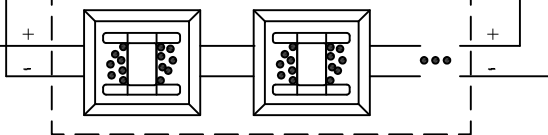

CLASS-A OUTPUT WIRING



SELECT CLASS-A WIRING BY SETTING THIS JUMPER

U.L. LISTED, 1481 POWER LIMITED 24VDC REGULATED SUPPLY FOR AUDIBLE DEVICES.

OUTPUT+
GND

OUT TO NEXT INTERFACE MODULE
S+ SC-

U.L. LISTED COMPATIBLE FIRE CONTROL PANEL
S+ SC-

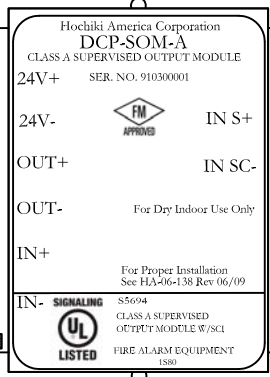

LEAVE TERMINALS "IN+" AND "IN-" UNCONNECTED

U.L. LISTED SIGNALING DEVICES

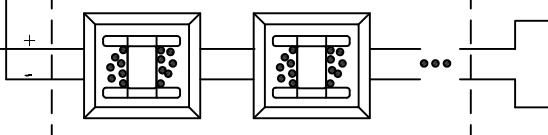

CLASS-B OUTPUT WIRING

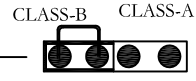

SELECT CLASS-B WIRING BY SETTING THIS JUMPER

E.O.L. DEVICE PART NUMBER 0400-01046

FIGURE 4
SOM-A WIRING DIAGRAM

One Year Limited Warranty

Hochiki America (HA) warrants its digital communication modules to be in conformance with it's own plans and specifications and to be free from defects in materials and workmanship under normal use and service for a period of one (1) year from date of delivery. All warranties are void and HA is not obligated to repair or replace equipment which has been repaired by others, abused, improperly installed, altered or otherwise misused or damaged or exposed to conditions outside the products specifications in any way. HA will not be responsible for any dismantling, reassembling or re-installation charges. Please contact HA's Sales department for proper procedure for claims and return of merchandise. This warranty is in lieu of all other warranties expressed or implied.