

## BONDING AND GROUNDING OVERVIEW

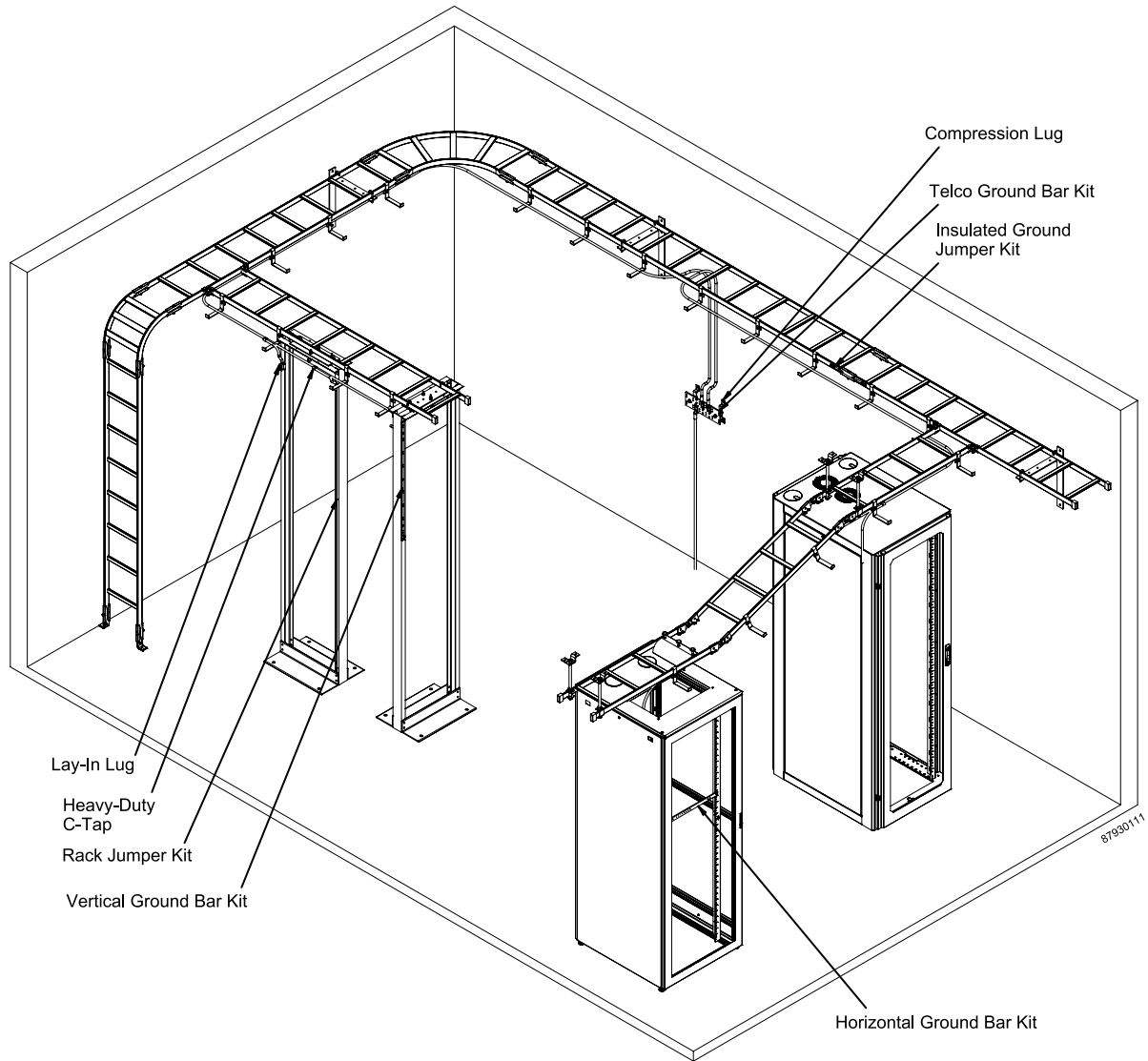

### INDUSTRY STANDARDS

#### Ground Bar Kits:

UL 467 Listed  
 cUL Listed per CSA C22.2 No. 41  
 File No. E319377

### APPLICATION

These components meet open frame rack and cabinet bonding and grounding requirements for telecommunication room and server room applications.

### FEATURES

- Components specially designed to efficiently facilitate reliable connections
- Enable system to meet equipment manufacturer grounding requirements
- Components fit EIA 310-D-rated open frame racks

### LAY-IN LUG

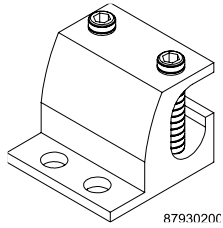

Dual-rated, UL486B listed lay-in lug bonds end of cable securely to rack. Made of electroplated 6061-T6 aluminum. Requires 3/16-in. hex key (not included).

BULLETIN: DBG

Catalog Number	For Cable Size Range	Size (in.)	Size (mm)	Pkg. Qty.
DGLG	#14 AWG to 2/0	1.75 x 1.50	44 x 38	10

### COMPRESSION LUGS

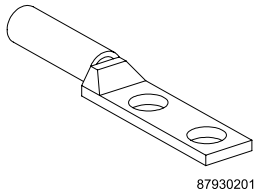

Compression lugs terminate copper or tinned-copper conductors for connection to busbars, cabinets, racks, and cable runway. Color-coded by conductor size. Made of electroplated, tinned copper. Require two screws (not included).

BULLETIN: DBG

Catalog Number	Cable Size (#)	On-Center Dimension Between Holes	Required Screw Size	Color Code	Pkg. Qty.
DGCL61	6	.625	1/4	Blue	10
DGCL62	6	1.00	3/8	Blue	10
DGCL21	2	.625	1/4	Brown	10
DGCL22	2	1.00	3/8	Brown	10
DGCL201	2/0	1.00	3/8	Black	10
DGCL402	4/0	1.00	3/8	Purple	10

### HEAVY-DUTY C-TAPS

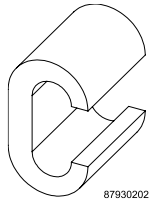

C-Taps splice two stranded or solid connectors together. Made of copper. Require a crimping tool (not included) to correctly tighten C-Taps around connectors.

BULLETIN: DBG

Catalog Number	Conductor Run	Conductor Tap	Pkg. Qty.
DGT1	#2 stranded or solid	#4 stranded, #8 solid	10
DGT2	#2 stranded or solid	#2 stranded or solid	10

### INSULATED GROUND JUMPER KIT

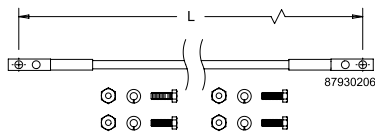

Fastens across splices to provide a secure ground between sections of ladder rack. Made of #6 AWG x 7 strand wire with green THW insulation and two-hole compression lugs mounted on each end. Includes fasteners.

BULLETIN: DBG

Catalog Number	Conductor Type	L (in.)	L (mm)
DGJ	#6-7 Stranded	12.00	305

cULus requires 2 kits per splice on all painted ladder sections

### RACK JUMPER KIT

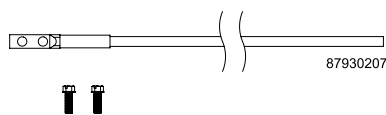

Grounds rack or cabinet to common bonding network under floor or overhead. Made of #6 AWG x 7 strand wire with green THW insulation and two-hole compression lug mounted on one end. Includes fasteners.

BULLETIN: DBG

Catalog Number	Conductor Type	Length (ft.)	Length (m)
DGRJ	#6-7 stranded	9	2.7

### TELECOMMUNICATIONS GROUND BAR KITS

Provide a convenient central location for connecting grounds from telecommunications equipment, computers, and other network equipment. Made of copper. Kits include ground bar with two mounting brackets, an assortment of connectors, and a tube of antioxidant.

BULLETIN: DBG

2-inch Wide Bar

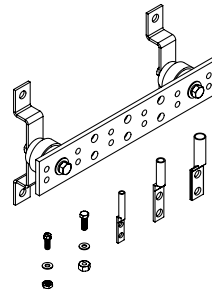

4-inch Wide Bar

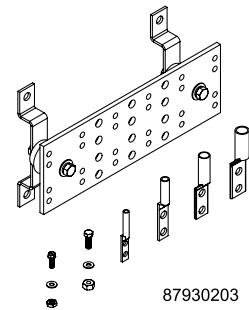

87930203

#### Standard Product

Catalog Number	Bar Size in./mm	No. of 5/16-in. Hole Sets	No. of 7/16-in. Hole Sets	#6 Wire Size (DGCL61)*	#2 Wire Size (DGCL22)*	#2/0 Wire Size (DGCL201)*	#4/0 Wire Size (DGCL402)*
DGTB212	2.00 x 12.00 x .25 51 x 305 x 6	6	3	6 lugs	3 lugs	1 lug	0 lugs
DGTB216	2.00 x 16.00 x .25 51 x 406 x 6	8	3	6 lugs	3 lugs	1 lug	0 lugs
DGTB412	4.00 x 12.00 x .25 102 x 305 x 6	12	6	6 lugs	3 lugs	1 lug	1 lug
DGTB420	4.00 x 20.00 x .25 102 x 508 x 6	24	6	6 lugs	3 lugs	1 lug	1 lug

\* Number of compression lugs included with Ground Bar Kits

### VERTICAL GROUND BAR KITS

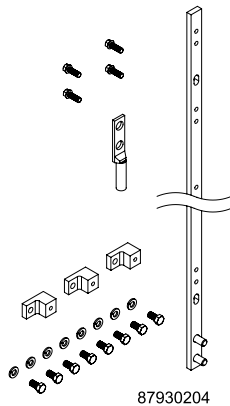

87930204

Mount vertically on rack, providing a convenient place to connect equipment grounds. Made of electrolytic tough-pitch 110 copper alloy. Kits include ground bar with compression lug for #2 wire, connection hardware, and mounting hardware.

BULLETIN: DBG

Catalog Number	Bar Size (in.)	Bar Size (mm)
DG36	36.00 x .625 x .25	914 x 16 x 6
DG72	72.00 x .625 x .25	1829 x 16 x 6

### HORIZONTAL GROUND BAR KITS

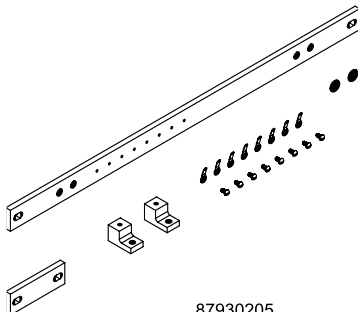

87930205

Mount horizontally on rack, providing a convenient place to connect equipment grounds. Made of electrolytic tough-pitch 110 copper alloy. Kits include ground bar with mounting hardware, eight #6-32 x 14 machine screws, and eight #6 ring terminals.

BULLETIN: DBG

Catalog Number	Bar Size (in.)	Bar Size (mm)
DG19	1.00 x 19.25 x .25	25 x 489 x 6
DG23	1.00 x 23.25 x .25	25 x 591 x 6

Notes