

DH50-B

Wireless Headset



USER MANUAL

Directory	2
1. Introduction	3
2. In the Box	3
3. Instructions	4
4. How to Use	5
4.1. Wearing Instructions	5
4.2. Power ON/OFF	5
4.3. USB Dongle set up	6
4.4. Bluetooth Pairing	6
4.5. Call Button	6
4.6. LED Indicator	7
4.7. Function Button	7
4.8. Volume Adjustment	7
4.9. Reset List	8
5. How to Charge	8
5.1. Charge	8
5.2. LED Indicator	8
6. Document Center	9
7. Safe Usage Guidelines	9

1. Introduction

DH50-B is a wireless headset with all-day comfort and high-quality sound performance.

All-day comfort wearing experience by flexible ID and finishing

Vocal-enhanced communication experience

Dual Busy-lights

Seamlessly switch between PC and smartphone



Features

- Noise-cancelling/vocal-enhanced retractable microphone and high-quality speaker provide better communication experience
- Intuitive rotating volume knob to adjust the level
- Up to 56h standby time, 3.5h charging time
- Dual Busy-lights provides the clue for others to interrupt or not
- Compatible with Apps and UC services of mainstream Softphone platforms

2. In the Box



DH50-B
Wireless headset



USB Dongle



Carry Bag

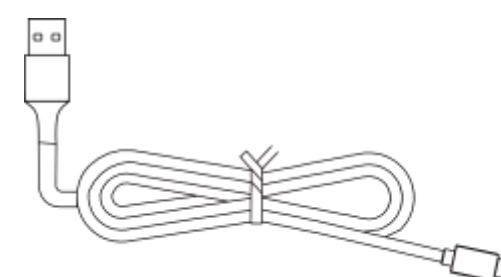

USB Cable

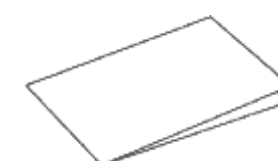

Quick Start Guide*1
Safety Information & Declaration*1

3. Instructions

3.1. DH50-B Wireless headset

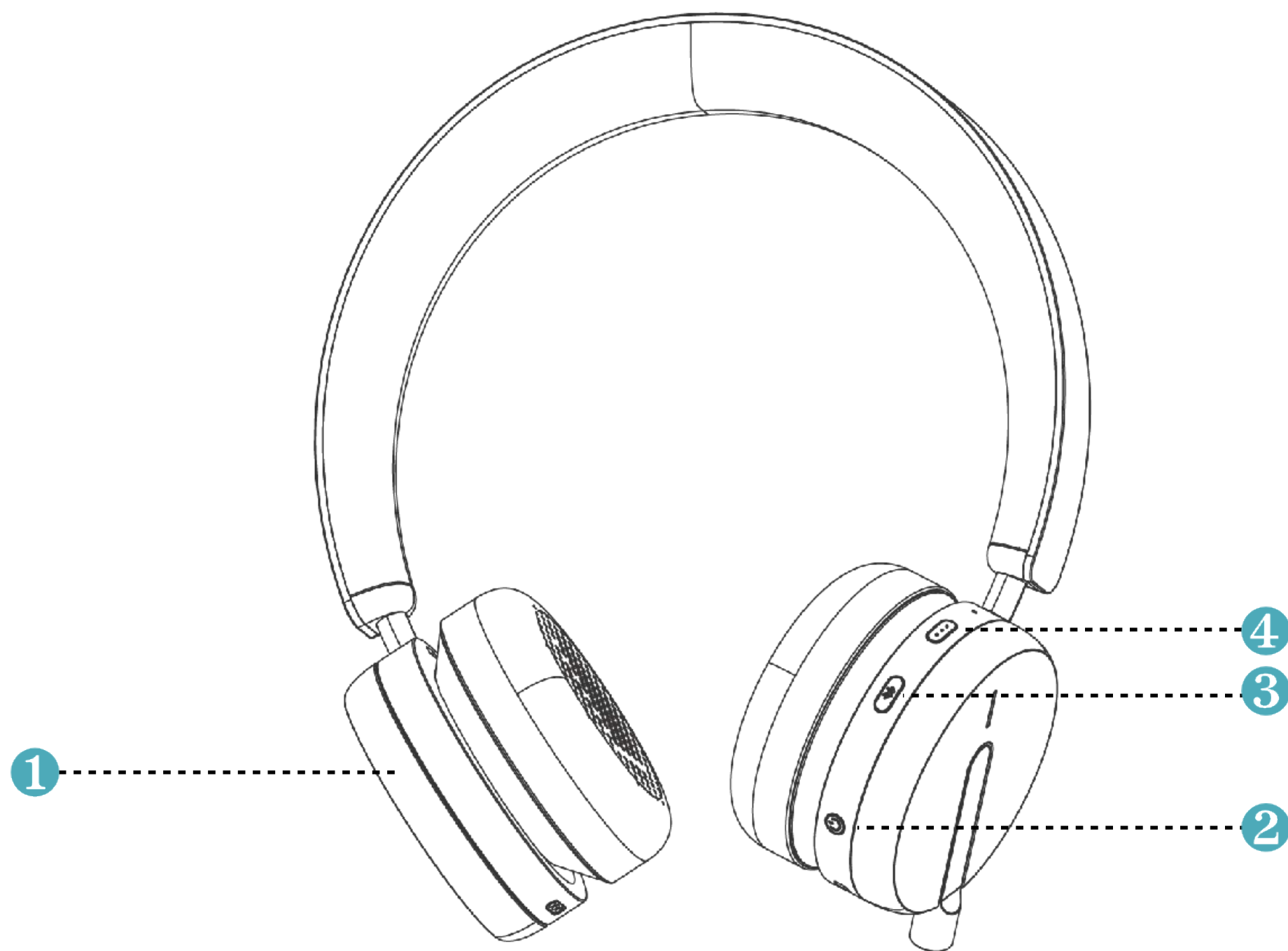

- ① Volume knob ④ Function button ⑦ Busylight
- ② Power button ⑤ USB-C Port ⑧ Retractable microphone
- ③ Bluetooth button ⑥ Call button

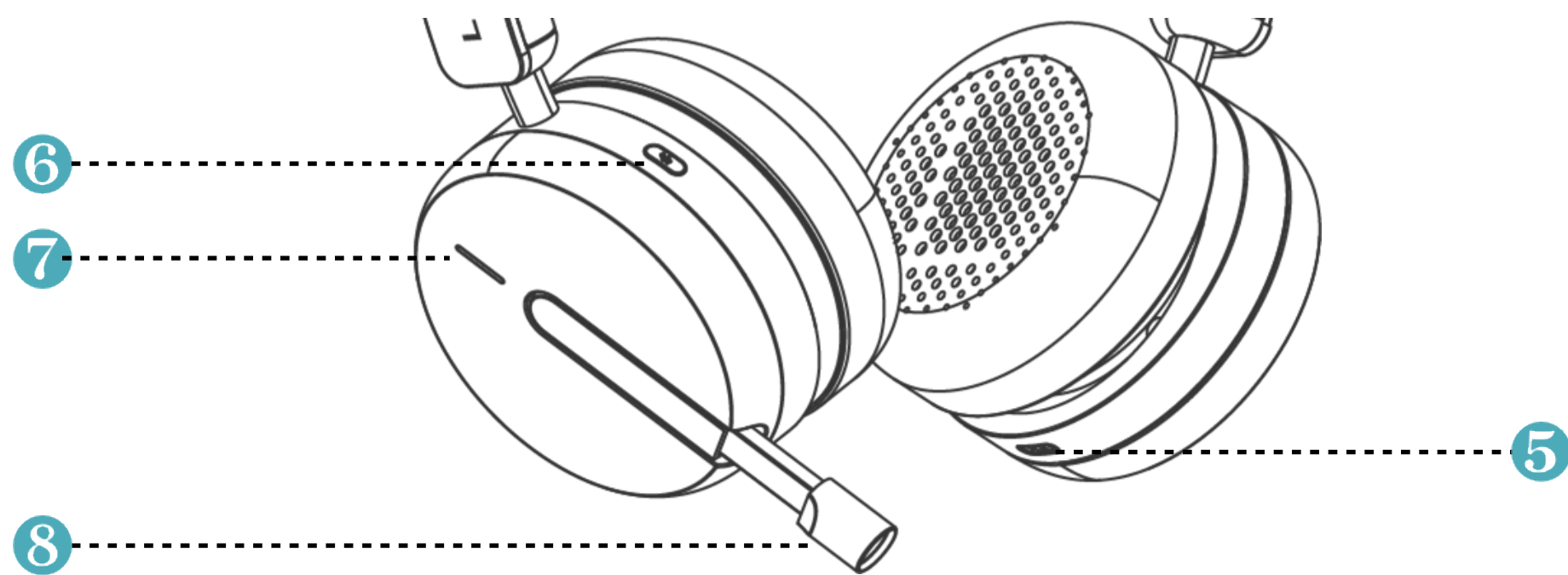

4. How to Use

4.1. Wearing Instructions

Adjust the headband up and down to a comfortable angle for your head.

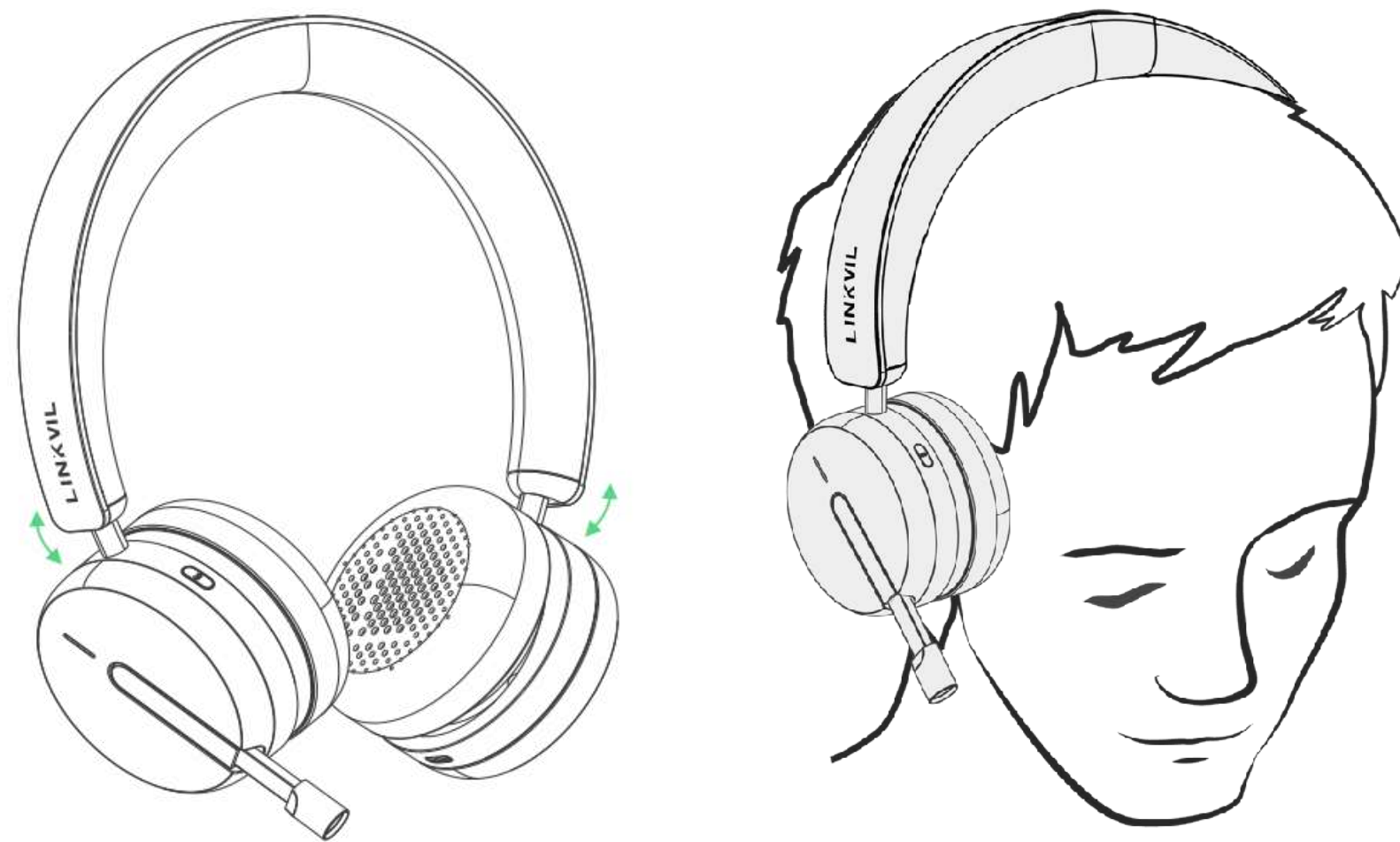

Push the retractable microphone back to mute, pull out to unmute, and the microphone is placed close to the mouth to achieve the best sound collection and noise reduction effect during calls.

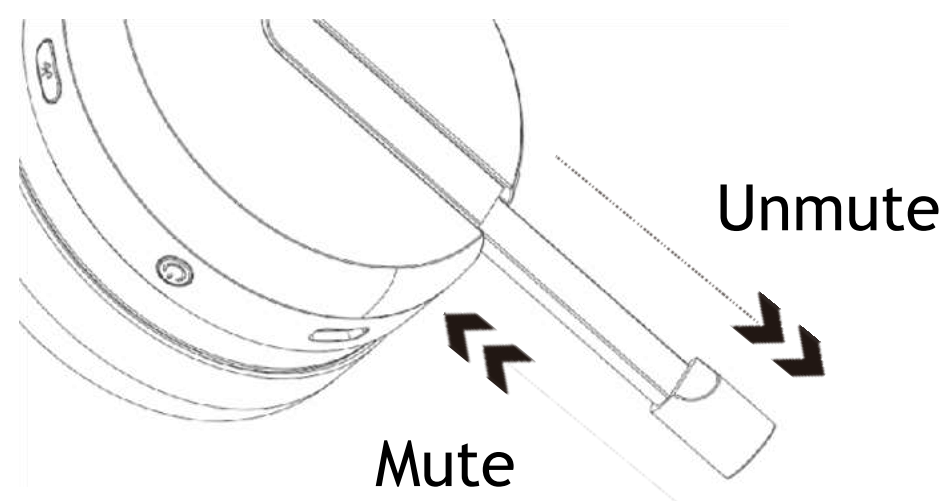

4.2. Power ON/OFF

Hold power button 2s to power ON/OFF, the busylight will be ON/OFF accordingly.

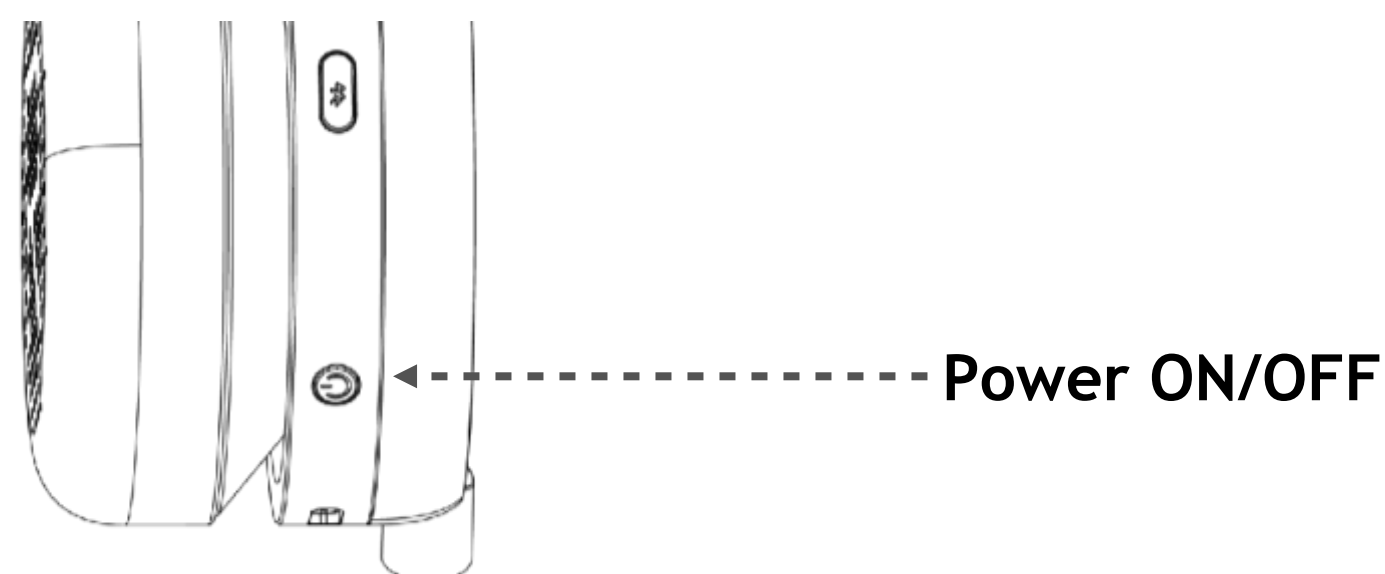

Tips

If there is no button operation or audio output within 1 hour, the DH50-B will automatically power OFF.

4.3. USB Dongle set up

Your USB Dongle is pre-paired with your wireless headset.



4.4. Bluetooth Pairing

Press and hold the Bluetooth button for 1s to enter pairing mode. From the list of Bluetooth devices, select the headset "Linkvil DH50-B" to pair it.

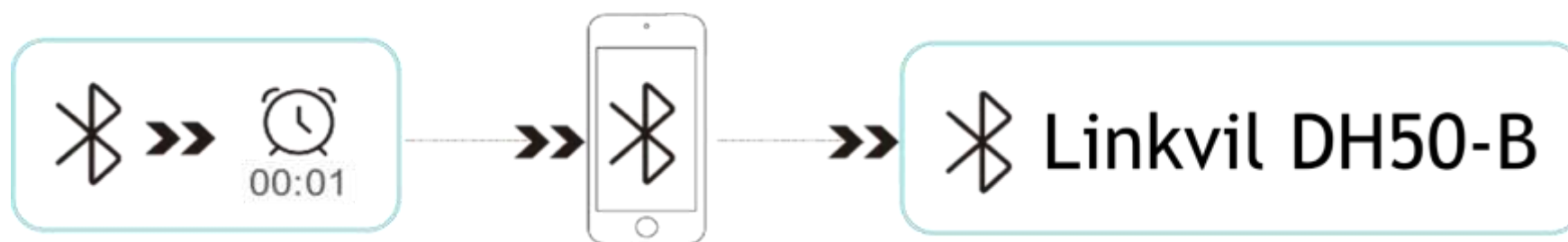

Press the Bluetooth button in pairing mode, the pairing will be cancelled.

4.5. Call Button

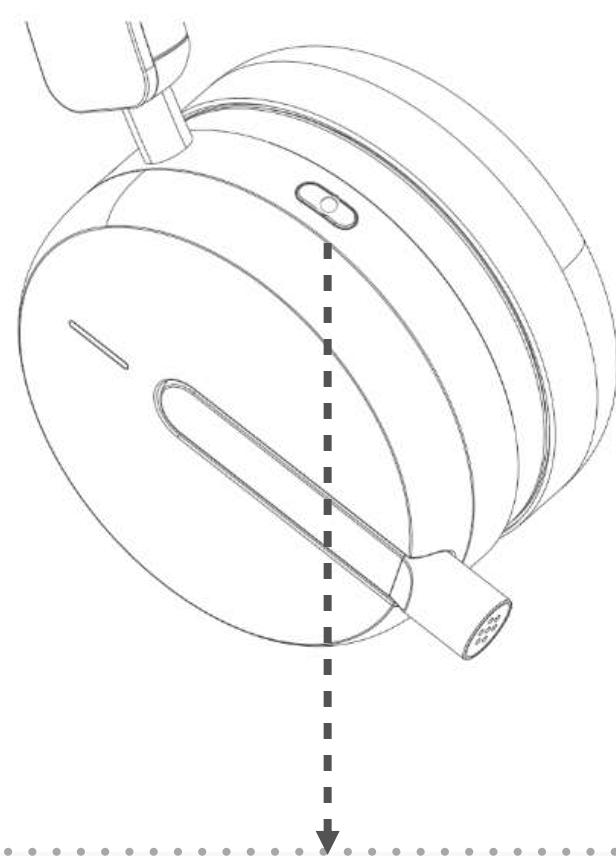

Play / Pause music	Answer / Hang up call	Reject call	Redial
Tap the call button	Tap the call button	Double click the call button when incoming call	Double click the call button when idle

4.6. LED Indicator

Event	LED Status	
Incoming call	Flashing Green	
In call	Solid Red	
Power ON	Solid Green 3s	
Power OFF	Flashing Green 3 times	
Pairing	Flashing Blue	
Connected	Solid Blue 3s	
Pairing failed	Flashing Blue 3s	
Reset list	Flashing Blue & Red	

4.7. Function Button

Press the function button once to inform the battery level via voice and double-click to notify the firmware version.

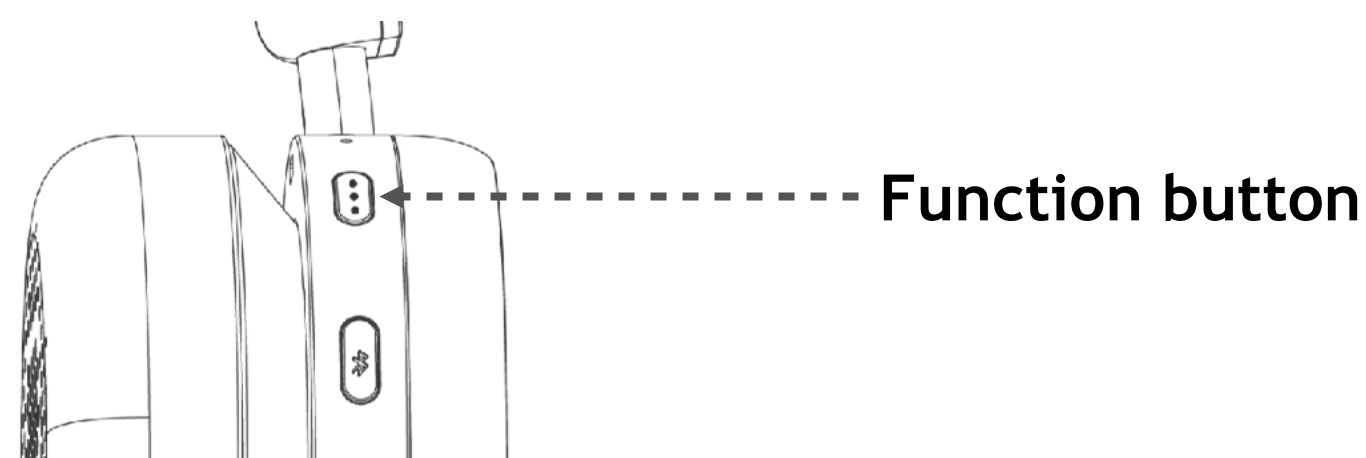

4.8. Volume Adjustment

Turn volume knob for volume + or volume - to adjust the volume level.

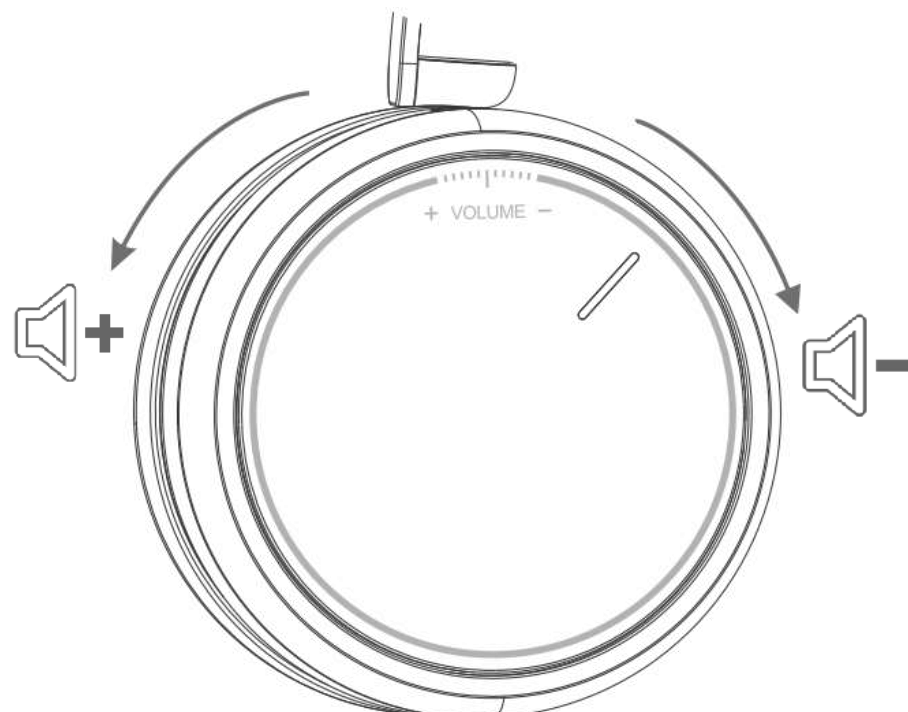

4.9. Reset List

Long-press both the Bluetooth button and the function button for 5s, then release them simultaneously to enter the “Automatic Clear Bluetooth Pairing List Mode” and receive a voice prompt saying, “Reset List”.

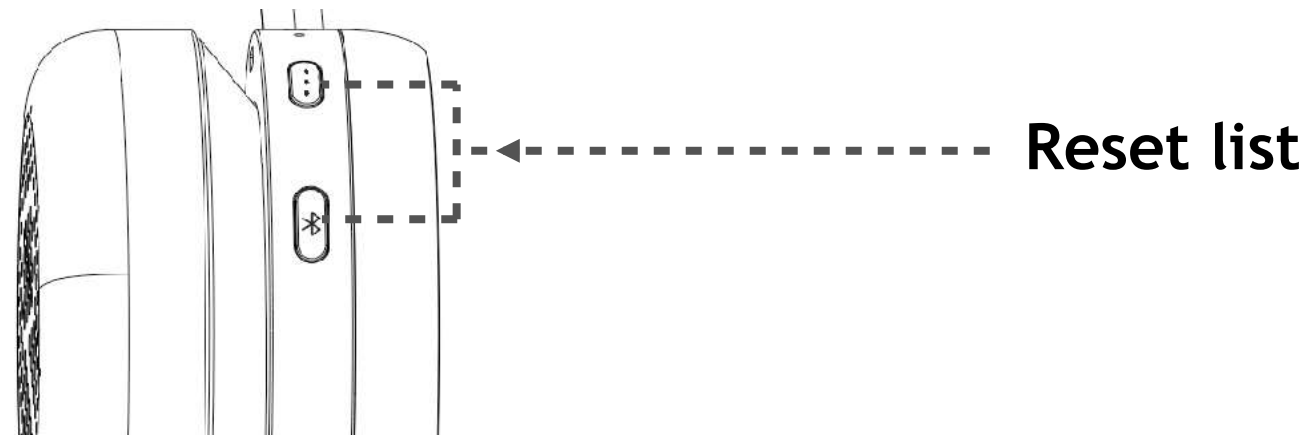

Tips

After resetting the Bluetooth pairing list, you can press the Bluetooth button again to initiate the re-pairing process. For more details, please refer to “Pairing” section.

5. How to Charge

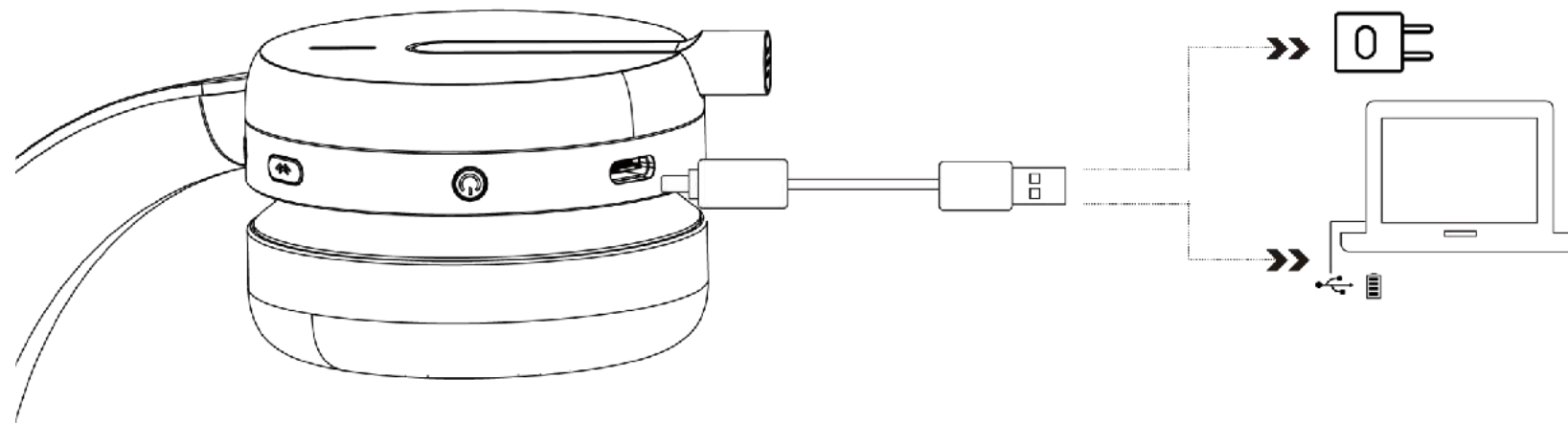

5.1. Charge

Connect the USB cable to power adapter* or computer, the busy-lights will light up automatically.



 * Excessive voltage may cause damage to the product. Using a power supply that exceeds the specified voltage can damage the device or pose other potential risks. To ensure the safety and proper operation of the device, be sure to use the power specifications provided in the packaging or an equivalent power supply.

5.2. LED Indicator

Event	LED Status	
Full of battery	Solid Green	
Charging	Solid Red	

 When the power of DH50-B drops below 10%, there will be sound notifications. Please charge DH50-B as soon as possible.

6. Document Center



Following documents can be downloaded from our document center:
Datasheet, Quick Start Guide, User manual, FAQ



<https://fanvil.com/service/doc/file/linkvils/linkvil/dh50-b/index.html>

7. Safe Usage Guidelines

- Do not open modify the product except for internal parts removal and replacement.
- Do not disassemble or attempt to service the product.
- This Product is safe under normal and reasonably foreseeable misuse operating conditions.
- If product is operating improperly, contact the authorized reseller.
- Product must be returned to the authorized reseller for any service or repair.
- This is not a Children's Product and is not intended for use by children under 14 years old.

About FANVIL

FANVIL Technology Co., Ltd. (FANVIL) is a leading global provider of A&V-IoT (Audio& Video- IoT) devices with three R&D centers in Beijing, Shenzhen, and Suzhou, China, and three factories in Huizhou and Shangrao, China, and Vietnam. FANVIL has focused on Unified Communication technology innovation for more than 20 years and provides SIP phones and SIP security industrial products in the global market. As the pioneer in applying standardized network communication technology and Audio & Video technologies to build A&V IoT, we are boosting the digital transformation for multiple industries.

About LINKVIL

As the sub-brand of FANVIL, LINKVIL will focus on the research and development of A&V-IoT wireless communication products. Based on Audio & Video -IoT, LINKVIL helps to achieve the full connection of wireless communication systems. LINKVIL builds a wireless communication Eco-system for multi-scenarios to help accelerate digital transformation.

Copyright

Copyright © 2024 FANVIL Technology Co., Ltd.

All rights reserved. No parts of this publication may be reproduced or transmitted in any form or by any means, electronic or mechanical, photocopying, recording, or otherwise, for any purpose, without the express written permission of FANVIL Technology Co., Ltd.

More Information

The above specifications may be updated in the future without prior notice. All hardware/software/physical features should be based on the final shipped products. For more information, please visit: www.fanvil.com

Compliance



FANVIL Technology Co., Ltd.

Web: www.fanvil.com

Add:10/F Block A, Dualshine Global Science Innovation Center, Honglang North 2nd Road, Bao'an District, Shenzhen, China

Copyright © 2024 Fanvil Technology Co., Ltd.