

Ruijie Reyee RG-NBR-E Series Routers

Hardware Installation and Reference Guide

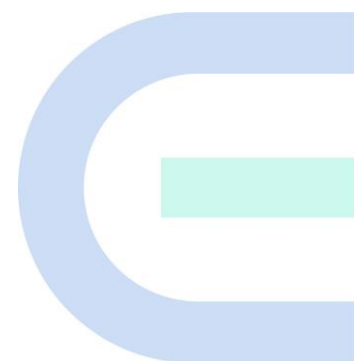

Copyright

Copyright © 2025 Ruijie Networks

All rights are reserved in this document and this statement.

Without the prior written consent of Ruijie Networks, any organization or individual shall not reproduce, extract, back up, modify, or propagate the content of this document in any manner or in any form, or translate it into other languages or use some or all parts of the document for commercial purposes.



and other Ruijie networks logos are trademarks of Ruijie Networks.

All other trademarks or registered trademarks mentioned in this document are owned by their respective owners.

Disclaimer

The products, services, or features you purchase are subject to commercial contracts and terms, and some or all of the products, services, or features described in this document may not be available for you to purchase or use. Except for the agreement in the contract, Ruijie Networks makes no explicit or implicit statements or warranties with respect to the content of this document.

The names, links, descriptions, screenshots, and any other information regarding third-party software mentioned in this document are provided for your reference only. Ruijie Networks does not explicitly or implicitly endorse or recommend the use of any third-party software and does not make any assurances or guarantees concerning the applicability, security, or legality of such software. You should choose and use third-party software based on your business requirements and obtain proper authorization. Ruijie Networks assumes no liability for any risks or damages arising from your use of third-party software.

The content of this document will be updated from time to time due to product version upgrades or other reasons, Ruijie Networks reserves the right to modify the content of the document without any notice or prompt.

This manual is designed merely as a user guide. Ruijie Networks has tried its best to ensure the accuracy and reliability of the content when compiling this manual, but it does not guarantee that the content of the manual is completely free of errors or omissions, and all the information in this manual does not constitute any explicit or implicit warranties.

Personal Data Statement

During the operation or troubleshooting of the products, services, or features you have purchased, certain personal data of users may be collected or used. Therefore, it is essential for you to establish and implement appropriate privacy policies, in compliance with the relevant laws and regulations of the applicable countries or regions, to ensure the complete protection of users' personal data.

If Ruijie Networks is involved in this process, we will strictly adhere to the relevant laws and regulations of the applicable countries or regions and take all necessary actions to safeguard users' personal data.

When discarding, reclaiming, or reusing a device, please ensure to back up or clear any stored data to avoid data leakage. For assistance, please contact our after-sales technical support.

Preface

Intended Audience

This document is intended for:

- Network engineers
- Technical support and servicing engineers
- Network administrators

Technical Support

- The official website of Ruijie Reyee: <https://reyee.ruijie.com>
- Technical Support Website: <https://reyee.ruijie.com/en-global/support>
- Case Portal: <https://www.ruijienetworks.com/support/caseportal>
- Community: <https://community.ruijienetworks.com>
- Technical Support Email: service_rj@ruijienetworks.com
- Online Robot/Live Chat: <https://reyee.ruijie.com/en-global/rita>

Conventions

1. Signs

This document also uses signs to indicate some important points during the operation. The meanings of these signs are as follows:

 Caution

An alert that calls attention to safety instruction that if not understood or followed can result in personal injury.

 Warning

An alert that calls attention to important rules and information that if not understood or followed can result in data loss or equipment damage.

 Note

An alert that calls attention to essential information that if not understood or followed can result in function failure or performance degradation.

 Instruction

An alert that contains additional or supplementary information that if not understood or followed will not lead to serious consequences.

 Specification

An alert that contains a description of product or version support.

2. Note

This manual provides installation steps, troubleshooting, technical specifications, and usage guidelines for cables and connectors. It is intended for users who want to understand the above and have extensive experience in network deployment and management, and assume that users are familiar with related terms and concepts.

Contents

Preface	I
1 Product Overview	1
1.1 Ruijie RG-NBR-E Series Enterprise-class Routers	1
1.1.1 Ruijie RG-NBR6205-E Enterprise-class Router	1
1.1.2 Ruijie RG-NBR6210-E Enterprise-class Router	3
1.1.3 Ruijie RG-NBR6215-E Enterprise-class Router	5
1.1.4 Ruijie RG-NBR6120-E Enterprise-class Router	7
1.2 Modules.....	9
1.2.1 Ruijie RG-NBR-HDD-1T Hard Disk	9
2 Preparations before Installation	11
2.1 Safety Precautions.....	11
2.2 Requirements on Installation Environment.....	11
2.2.1 Temperature/Humidity Requirements	11
2.2.2 Cleanliness Requirements.....	12
2.2.3 Anti-Static Requirements	12
2.2.4 Anti-Interference Requirements	13
2.2.5 Checking the Installation Location	13
2.3 Installation Tools and Devices	13
3 Installing the Enterprise-class Router	15
3.1 Installation Procedure of Enterprise-class Router	15
3.2 Mounting the Enterprise-class Router	15
3.2.1 Mounting into a Cabinet.....	15
3.2.2 Mounting on a Workbench.....	16
3.3 Installing Power Cables	16
3.4 EMC Grounding	16
3.5 Checking after the Installation	16
4 Starting and Configuring the Enterprise-class Router	18
4.1 Starting a Enterprise-class Router.....	18
4.1.1 Building Configuration Environment	18
4.1.2 Powering on the Enterprise-class Router	20
4.1.3 Starting Process.....	21
4.2 Starting the Enterprise-class Router.....	22
5 Troubleshooting.....	23
1.2 Power Supply Troubleshooting.....	23
1.3 Configuration System Troubleshooting	23

1 Product Overview

Ruijie RG-NBR-E series enterprise-class routers employ the global-leading semiconductor technologies and communication control technologies. The enterprise-class routers are completely developed as per international standards and are similar to the mainstream enterprise-class routers in the international market. By reading this manual, network administrator being familiar with mainstream enterprise-class router configuration commands can easily use this product without training.

1.1 Ruijie RG-NBR-E Series Enterprise-class Routers

1.1.1 Ruijie RG-NBR6205-E Enterprise-class Router

1. Appearance of Ruijie RG-NBR6205-E Enterprise-class Router

Figure 1-1 Front Panel of Ruijie RG-NBR6205-E Enterprise-class Router

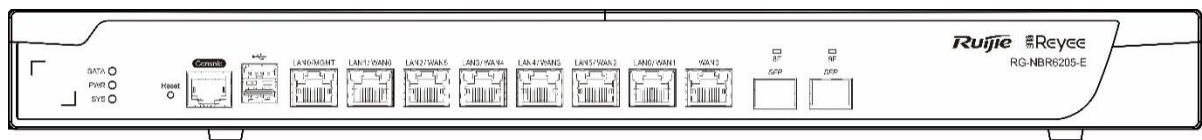
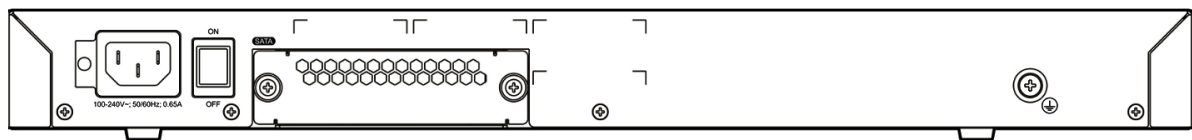

Figure 1-2 Backpanel of Ruijie RG-NBR6205-E Enterprise-class Router



2. Specifications of Ruijie RG-NBR6205-E Enterprise-class Router

Table 1-1 Specifications of Ruijie RG-NBR6205-E Enterprise-class Router

Item	Description
Storage	DDR4 SDRAM: 2 GB
	BOOTROM: 8 MB
	eMMC: 8 GB
	SATA: 1 TB (Optional)
I/O Setup	8 copper ports. Supports 8 10/100/1000 M (copper) fast Ethernet ports and automatic recognition of network cables and cross-over cables. By default, ports LAN0, LAN1, LAN2, LAN3, LAN4 and LAN5 are LAN ports, while ports WAN0 and WAN1 are WAN ports. Ports LAN1, LAN2, LAN3, LAN4, LAN5 and WAN1 support WAN/LAN switchover.
	2 SFP ports. Supports 1000BASE-SX/LX/ZX mini GBIC and GE-SFP-LX20/LH40-BIDI SFP modules. By default, the SFP ports are WAN ports, and support WAN/LAN switchover.
	i The router itself does not transmit optical signals. You must install an optical transceiver module on the switch to convert optical signals into electrical signals.
	1 management port (in bridging mode)

	1 console port
	2 USB ports
Hardware Disk Module	1 hardware disk module (optional)
Hot Swapping	Hot swapping of hardware disk module: not support
Interface Standard	Ethernet: 10Base-T/100Base-TX/1000Base-TX, 1000BASE-SX/LX/ZX, 10GBASE-SR/LR/ZR
	Console port: RS-232
Dimension (W x H x D)	440 mm x 43.6 mm x 200 mm (excluding the foot pad)
Voltage	100–240 V; 50/60 Hz
Power Consumption	Less than 25 W
Working Environment	Temperature: 0°C to 45°C (32°F to 113°F)
	Humidity: 10% to 90% RH (non-condensing)

Instruction

Not all USB disks are supported. The Kingston USB disk with FAT 32 is recommended.

Note

- Please avoid the vibration and collision in the process of moving and usage.
- To power off the device with the hard disk module inserted, please turn off the power button. Do not remove the power cable until the PWR LED turns off, or else the hardware disk will be damaged.

Warning

This product contains a button battery. If the button battery is swallowed, it may cause severe internal burns and possibly death within 2 hours.

- Keep new and used batteries away from children.
- If the battery compartment is not closed securely, stop using the product and keep it away from children.
- Seek medical help immediately if you believe a battery may have been swallowed or retained in any part of your body.

3. LED Indicators of Ruijie RG-NBR6205-E Enterprise-class Router

Table 1-2 LED Indicators of Ruijie RG-NBR6205-E Enterprise-class Router

LED Indicators	Working Status
PWR	Solid green indicates the device is receiving power properly. Off indicates the power module is faulty or not powered on.
SYS	Blinking green indicates the system is being initialized. Solid green indicates system initialization has completed. Solid red indicates system warning.
SATA	Solid green indicates the SATA hard disk is inserted. Blinking green indicates data reading/writing.
Link/ACT Indicators of 0-7 Copper Ports	Solid green indicates that the port is connected at 10/100/1000 Mbps.

	Blinking green indicates that the port is receiving or transmitting traffic at 10/100/1000 Mbps.
Speed Indicators of 0-7 Copper Ports	Solid orange indicates that the port is connected at 1000 Mbps. Off indicates that the port is connected at 10/100 Mbps.
Indicators of 8F-9F SFP Ports	Solid green indicates that the port is connected. Blinking green indicates that the port is receiving or transmitting traffic.

1.1.2 Ruijie RG-NBR6210-E Enterprise-class Router

1. Appearance of Ruijie RG-NBR6210-E Enterprise-class Router

Figure 1-3 Front Panel of Ruijie RG-NBR6210-E Enterprise-class Router

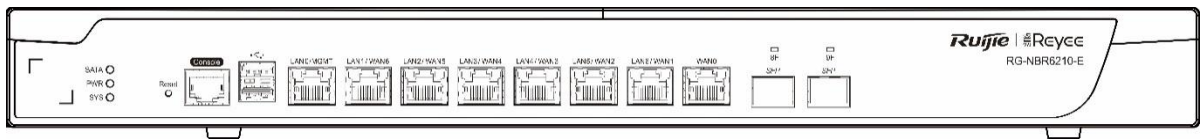
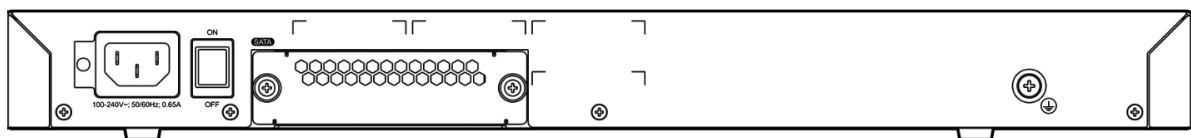

Figure 1-4 Backpanel of Ruijie RG-NBR6210-E Enterprise-class Router



2. Specifications of Ruijie RG-NBR6210-E Enterprise-class Router

Table 1-3 Specifications of Ruijie RG-NBR6210-E Enterprise-class Router

Item	Description
Storage	DDR4 SDRAM: 2 GB
	BOOTROM: 8 MB
	eMMC: 8 GB
	SATA: 1 TB (Optional)
I/O Setup	8 copper ports. Supports 8 10/100/1000 M (copper) fast Ethernet ports and automatic recognition of network cables and cross-over cables. By default, ports LAN0, LAN1, LAN2, LAN3, LAN4 and LAN5 are LAN ports, while ports WAN0 and WAN1 are WAN ports. Ports LAN1, LAN2, LAN3, LAN4, LAN5 and WAN1 support WAN/LAN switchover.
	2 SFP ports. Supports 1000BASE-SX/LX/ZX mini GBIC and GE-SFP-LX20/LH40-BIDI SFP modules. By default, the SFP ports are WAN ports, and support WAN/LAN switchover.
	i The router itself does not transmit optical signals. You must install an optical transceiver module on the switch to convert optical signals into electrical signals.
	1 management port (in bridging mode)
	1 console port

	2 USB ports
Hardware Disk Module	1 hardware disk module (optional)
Hot Swapping	Hot swapping of hardware disk module: not support
Interface Standard	Ethernet: 10Base-T/100Base-TX/1000Base-TX, 1000BASE-SX/LX/ZX, 10GBASE-SR/LR/ZR
	Console port: RS-232
Dimension (W x H x D)	440 mm x 43.6 mm x 200 mm (excluding the foot pad)
Voltage	100–240 V; 50/60 Hz
Power Consumption	Less than 25 W
Working Environment	Temperature: 0°C to 45°C (32°F to 113°F)
	Humidity: 10% to 90% RH (non-condensing)

i Instruction

Not all USB disks are supported. The Kingston USB disk with FAT 32 is recommended.

⚠ Note

- Please avoid the vibration and collision in the process of moving and usage.
- To power off the device with the hard disk module inserted, please turn off the power button. Do not remove the power cable until the PWR LED turns off, or else the hardware disk will be damaged.

! Warning

This product contains a button battery. If the button battery is swallowed, it may cause severe internal burns and possibly death within 2 hours.

- Keep new and used batteries away from children.
- If the battery compartment is not closed securely, stop using the product and keep it away from children.
- Seek medical help immediately if you believe a battery may have been swallowed or retained in any part of your body.

3. LED Indicators of Ruijie RG-NBR6210-E Enterprise-class Router

Table 1-4 LED Indicators of Ruijie RG-NBR6210-E Enterprise-class Router

LED Indicators	Working Status
PWR	Solid green indicates the device is receiving power properly. Off indicates the power module is faulty or not powered on.
SYS	Blinking green indicates the system is being initialized. Solid green indicates system initialization has completed. Solid red indicates system warning.
SATA	Solid green indicates the SATA hard disk is inserted. Blinking green indicates data reading/writing.
Link/ACT Indicators of 0-7 Copper Ports	Solid green indicates that the port is connected at 10/100/1000 Mbps. Blinking green indicates that the port is receiving or transmitting traffic at 10/100/1000 Mbps.

Speed Indicators of 0-7 Copper Ports	Solid orange indicates that the port is connected at 1000 Mbps. Off indicates that the port is connected at 10/100 Mbps.
Indicators of 8F-9F SFP Ports	Solid green indicates that the port is connected. Blinking green indicates that the port is receiving or transmitting traffic.

1.1.3 Ruijie RG-NBR6215-E Enterprise-class Router

1. Appearance of Ruijie RG-NBR6215-E Enterprise-class Router

Figure 1-5 Front Panel of Ruijie RG-NBR6215-E Enterprise-class Router

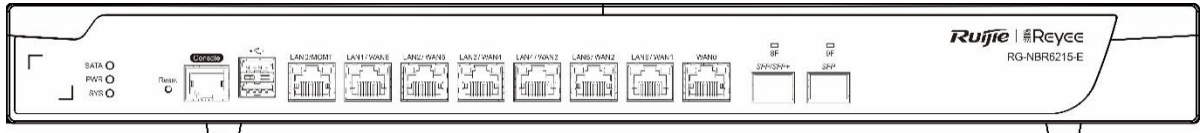
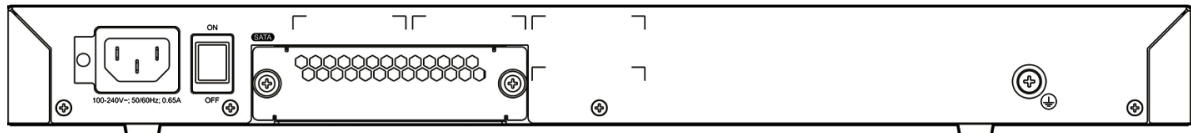

Figure 1-6 Backpanel of Ruijie RG-NBR6215-E Enterprise-class Router



2. Specifications of Ruijie RG-NBR6215-E Enterprise-class Router

Table 1-5 Specifications of Ruijie RG-NBR6215-E Enterprise-class Router

Item	Description
Storage	DDR4 SDRAM: 2 GB
	BOOTROM: 8 MB
	eMMC: 8 GB
	SATA: 1 TB (Optional)
I/O Setup	8 copper ports. Supports 8 10/100/1000 M (copper) fast Ethernet ports and automatic recognition of network cables and cross-over cables. By default, ports LAN0, LAN1, LAN2, LAN3, LAN4 and LAN5 are LAN ports, while ports WAN0 and WAN1 are WAN ports. Ports LAN1, LAN2, LAN3, LAN4, LAN5 and WAN1 support WAN/LAN switchover.
	1 SFP+/SFP port (SFP+ port by default). Supports XG-SFP-SR-MM850, XG-SFP-LR-SM1310, XG-SFP-ER-SM1550 and BiDi modules. The port is a LAN port by default and support WAN/LAN switchover. It can be also used as an SFP port, supporting 1000BASE-SX/LX/ZX mini GBIC and GE-SFP-LX20/LH40-BIDI modules.
	1 SFP port. Supports 1000BASE-SX/LX/ZX mini GBIC and GE-SFP-LX20/LH40-BIDI modules. The port is a WAN port by default and supports WAN/LAN switchover.
	i The router itself does not transmit optical signals. You must install an optical transceiver module on the switch to convert optical signals into electrical signals.
	1 management port (in bridging mode)

	1 console port
	2 USB ports
Hardware Disk Module	1 hardware disk module (optional)
Hot Swapping	Hot swapping of hardware disk module: not support
Interface Standard	Ethernet: 10Base-T/100Base-TX/1000Base-TX, 1000BASE-SX/LX/ZX, 10GBASE-SR/LR/ZR
	Console port: RS-232
Dimension (W x H x D)	440 mm x 43.6 mm x 200 mm (excluding the foot pad)
Voltage	100–240 V; 50/60 Hz
Power Consumption	Less than 25 W
Working Environment	Temperature: 0°C to 45°C (32°F to 113°F)
	Humidity: 10% to 90% RH (non-condensing)

Instruction

Not all USB disks are supported. The Kingston USB disk with FAT 32 is recommended.

Note

- Please avoid the vibration and collision in the process of moving and usage.
- To power off the device with the hard disk module inserted, please turn off the power button. Do not remove the power cable until the PWR LED turns off, or else the hardware disk will be damaged.
- The SFP+ port does not support the direct connection between two RG-EG3200 series or RG-NBR6200-E series devices via the SFP module or fiber cables.

Warning

This product contains a button battery. If the button battery is swallowed, it may cause severe internal burns and possibly death within 2 hours.

- Keep new and used batteries away from children.
- If the battery compartment is not closed securely, stop using the product and keep it away from children.
- Seek medical help immediately if you believe a battery may have been swallowed or retained in any part of your body.

3. LED Indicators of Ruijie RG-NBR6215-E Enterprise-class Router

Table 1-6 LED Indicators of Ruijie RG-NBR6215-E Enterprise-class Router

LED Indicators	Working Status
PWR	Solid green indicates the device is receiving power properly. Off indicates the power module is faulty or not powered on.
SYS	Blinking green indicates the system is being initialized. Solid green indicates system initialization has completed. Solid red indicates system warning.
SATA	Solid green indicates the SATA hard disk is inserted. Blinking green indicates data reading/writing.

Link/ACT Indicators of 0-7 Copper Ports	Solid green indicates that the port is connected at 10/100/1000 Mbps. Blinking green indicates that the port is receiving or transmitting traffic at 10/100/1000 Mbps.
Speed Indicators of 0-7 Copper Ports	Solid orange indicates that the port is connected at 1000 Mbps. Off indicates that the port is connected at 10/100 Mbps.
Indicators of 8F-9F SFP Ports	Solid green indicates that the port is connected. Blinking green indicates that the port is receiving or transmitting traffic.

1.1.4 Ruijie RG-NBR6120-E Enterprise-class Router

1. Appearance of Ruijie RG-NBR6120-E Enterprise-class Router

Figure 1-7 Front Panel of Ruijie RG-NBR6120-E Enterprise-class Router

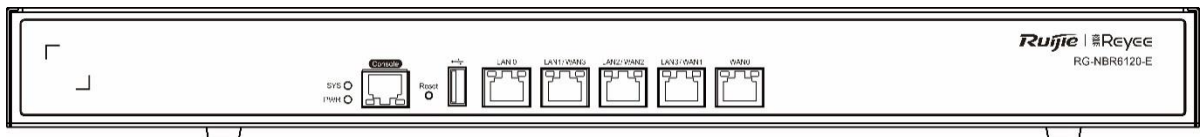
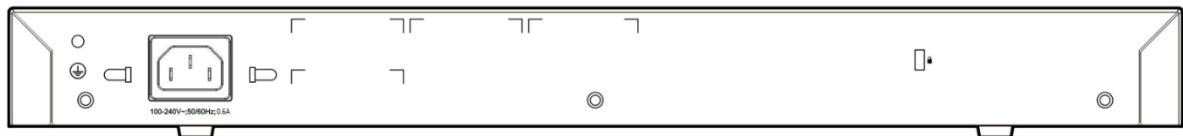

Figure 1-8 Backpanel of Ruijie RG-NBR6120-E Enterprise-class Router



2. Specifications of Ruijie RG-NBR6120-E Enterprise-class Router

Table 1-7 Specifications of Ruijie RG-NBR6120-E Enterprise-class Router

Item	Description
Storage	DDR3 SDRAM: 512 MB
	BOOTROM: 2 MB
	eMMC: 4 GB
I/O Setup	WAN ports.: Supports 2 10/100/1000 M (copper) fast Ethernet ports and automatic recognition of network cables and cross-over cables. Ports WAN1 support WAN/LAN switchover.
	LAN ports: Supports 3 10/100/1000 M (copper) fast Ethernet ports and automatic recognition of network cables and cross-over cables. Ports LAN1 and LAN2 support WAN/LAN switchover.
	1 console port
	1 USB ports
Interface Standard	Ethernet: 10Base-T/100Base-TX/1000Base-TX
	Console port: RS-232
Dimension (W x H x D)	440 mm x 43.6 mm x 200 mm (excluding the foot pad)

Voltage	100–240 V; 50/60 Hz
Power Consumption	Less than 20 W
Working Environment	Temperature: -5°C to 45°C (23°F to 113°F)
	Humidity: 10% to 90% RH (non-condensing)

Instruction

Not all USB disks are supported. The Kingston USB disk with FAT 32 is recommended.

Warning

This product contains a button battery. If the button battery is swallowed, it may cause severe internal burns and possibly death within 2 hours.

- Keep new and used batteries away from children.
- If the battery compartment is not closed securely, stop using the product and keep it away from children.
- Seek medical help immediately if you believe a battery may have been swallowed or retained in any part of your body.

3. LED Indicators of Ruijie RG-NBR6120-E Enterprise-class Router

Table 1-8 LED Indicators of Ruijie RG-NBR6120-E Enterprise-class Router

LED Indicators	Working Status
PWR	Solid green indicates the device is receiving power properly. Off indicates the power module is faulty or not powered on.
SYS	Blinking green indicates the system is being initialized. Solid green indicates system initialization has completed.
Link/ACT	Solid green indicates that the port is connected at 10/100/1000 Mbps. Blinking green indicates that the port is receiving or transmitting traffic at 10/100/1000 Mbps.
Speed	Solid orange indicates that the port is connected at 1000 Mbps. Off indicates that the port is connected at 10/100 Mbps.

1.2 Modules

1.2.1 Ruijie RG-NBR-HDD-1T Hard Disk

Figure 1-9 Appearance of the RG-NBR-HDD-1T Hard Disk

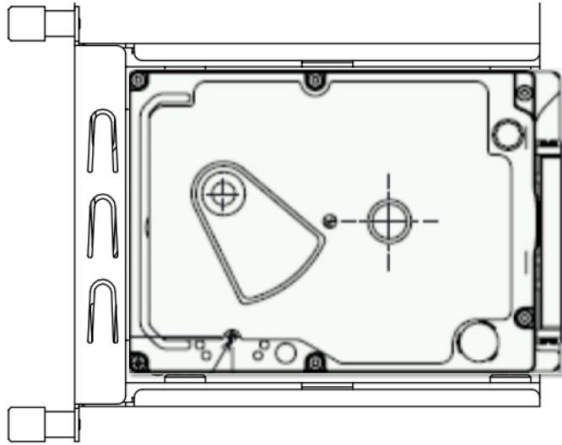

Table 1-9 Attribute Description of the RG-NBR-HDD-1T Hard Disk

Attributes	Description
Applicable Models	RG-NBR6205-E, RG-NBR6210-E, RG-NBR6215-E
Dimensions (L x W x H)	130 mm x 102 mm x 27 mm
Type	HDD
Memory	1T
Operational Altitude	0 to 3,000m
Hot Swapping	Not support

Instruction

- Software has been installed in the hard disk with the format “.EXT3”. Therefore, plug and play is allowed for the hard disk.
- You have to reset the device after inserting a hard disk.

Note

- Please avoid the vibration and collision in the process of moving and usage.
- Products should be transported in original packets.
- Errors might occur if a RG-NBR-HDD-1T hard disk is used at an altitude over 3,000m.

Do not press!



- Do not press the cover of a hard disk.

Do not cover this hole

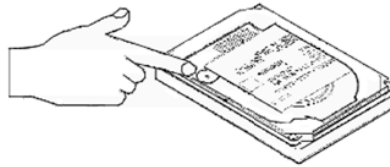

- Do not cover the air hole of a hard disk.



- Do not toss, jolt, or shake the hard disk.



- Do not touch the circuit board.

To install the hard disk for the RG-NBR6200-E series:

- (1) Power off the device ;
- (2) Loosen screws of the hard disk on the back panel of the device;
- (3) Remove the filler panel of the hard disk;
- (4) Insert the hard disk, and then tighten the screws.

Figure 1-10 Installing the Hard Disk

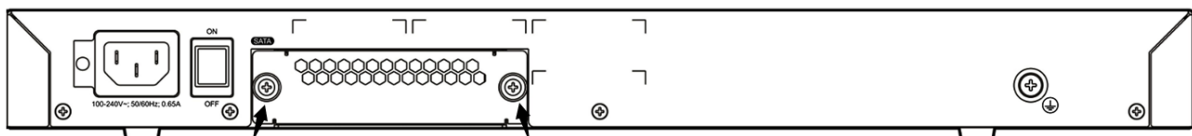

2 Preparations before Installation

2.1 Safety Precautions

The enterprise-class router acts as the critical transfer station of network connections, and its normal service is crucial to the normal operation of the entire network.

The following safety suggestions are applicable to the installation and use of the enterprise-class router:

- Do not place the device in a watery place and prevent any liquid from entering into it.
- Keep the device away from heat sources.
- Ensure the normal grounding of device.
- Wear an anti-static wrist strap to install and maintain the device.
- Do not wear loose clothes to avoid hooking any parts. Before operation, tighten your band, shawl and sleeves.
- Keep tools and parts away from the walkway to avoid damage.
- Use the uninterruptible power supply (UPS) to avoid power failure and other interferences.
- If the system time is incorrect, check whether you have set the clock. If the clock is not set, the time may not be correct; if the clock has been set precisely and the time is still incorrect, the built-in button cell of device may have ran out, which is typically happened after 10-year service.

Instruction

- Use of wrong battery may cause damage to the device. Do not replace the battery by yourself. Please contact the Technical Assistance Center of Ruijie Networks for help.
 - This is a Class-A product which may cause radio interference in the living environment. In such a case, the user may need to take feasible measures against such interference.
-

Note

- Install and use the device in restricted access locations.
 - Invite professionals and related technicians to install this type of device.
-

2.2 Requirements on Installation Environment

Ruijie RG-NBR-E series enterprise-class router products are for indoor use only. To ensure normal operation and prolong their service life, the installation site must meet the following requirements:

Temperature/humidity requirements

- Cleanliness requirements
- Anti-static requirements
- Anti-interference requirements
- Lightning protection requirements
- Checking the installation location

2.2.1 Temperature/Humidity Requirements

To ensure normal operation and prolong the service life of the device, the equipment room must maintain constant temperature and humidity. If the equipment room is overheated for a long time, the insulation materials may result in defective insulation and even electric leakage. If the relative humidity is low, the insulation spacer may result in dry shrinkage, which will make screws looser and easily generate static electricity in the dry environment, thus damaging the interior circuits on the device. Excessively high temperature will accelerate the aging of insulation materials and compromise the reliability and even service life of the device. The

temperature/humidity requirements are shown below (detailed difference between products is described in the chapter of "Product Overview"):

Table 1-10 Temperature and Humidity Requirements of Ruijie RG-NBR-E Series Enterprise-class Routers

Temperature		Relative Humidity	
Long-term working condition	Short-term working condition	Long-term working condition	Short-term working condition
15°C to 30°C/ 59°F to 86°F	0°C to 45°C/ 32°F to 113°F	40% to 65%	10% to 90%

i Instruction

- The working temperature/humidity indicates the value measured at 1.5 m above the floor and 0.4 m ahead of the equipment frame when there is no protection plate on the front and rear side of the equipment frame.
- Short-term working condition refers to the continuous operation no exceeding 48 hours or accumulative operations no exceeding 15 days in a year.
- Extremely harsh working environment generally refers to the ambient temperature and humidity which may be encountered when the equipment room air-conditioning system fails but will recover in less than 5 hours every time.

2.2.2 Cleanliness Requirements

The dust is also a major threat to the safe operation of device. The dust accumulated on the device may cause electrostatic adsorption and result in poor contact. It will not only compromise the service life of device but also cause communication failure. When the indoor relative humidity is low, such electrostatic adsorption will incur more easily.

Table 1-11 The Equipment Room Dust Content and Particle Size Requirements of Ruijie RG-NBR-E Series Enterprise-class Routers

Maximum Diameter (μm)	0.5	1	3	5
Maximum Density (Particles/m ³)	1.4×10^7	7×10^5	2.4×10^5	1.3×10^5

Apart from the dust, the device is also sensitive to the hydrochloric acid sulfide contained in the air. These noxious gases will accelerate metal wastage and the aging of certain parts. The upper limits of noxious gases (Sulfur dioxide, Sulfured hydrogen, Nitrogen dioxide, Ammonia and Chlorine) in the equipment room are shown in Table 2-3:

Table 1-12 Upper Limits of Noxious Gases of Ruijie RG-NBR-E Series Enterprise-class Routers

Gas	Average (mg/m ³)	Maximum (mg/m ³)
Sulfur dioxide	0.2	1.5
Sulfured hydrogen	0.006	0.03
Nitrogen dioxide	0.04	0.15
Ammonia	0.05	0.15
Chlorine	0.01	0.3

2.2.3 Anti-Static Requirements

The enterprise-class router has already given consideration to electrostatic prevention during circuit design, but excessively strong static electricity will still damage the circuit board. The static electricity in the communication network connected with the device is mainly from:

- Outdoor high-voltage transmission line, lightning and other exterior electric fields.
- Indoor environment, flooring material, complete appliance structure and other in-house systems.

To avoid the damage caused by static electricity, we shall:

- Properly ground the device and floor;
- Apply indoor dust control;
- Maintain proper temperature and humidity;

Pay attention to the following for modules or circuit boards which can be disassembled by the user:

- Before touching the circuit board, wear an anti-static wrist strap and an anti-static uniform;
- Place the circuit board disassembled face up on the antistatic workbench or in the electromagnetic shielded bag.
- When observing or transferring the circuit board of enterprise-class router, touch the outer edge of circuit board and avoid direct contact with the components on the circuit board.

2.2.4 Anti-Interference Requirements

The interference as mentioned herein refers to electromagnetic or electrical interference, and the anti-interference requirements are described below:

- Effective power grid interference control measures shall be taken against the power supply system.
- The working ground of the enterprise-class router shall be kept far away from the grounding device or lightning grounding device of power equipment instead of sharing.
- The router shall be kept far away from high-power radio-transmitting station, radar-transmitting station and other high-frequency & heavy-current devices.
- Electromagnetic shielding measures shall be taken whenever necessary.

2.2.5 Checking the Installation Location

No matter the enterprise-class router is installed in the cabinet or on the workbench, the following requirements shall be met:

- Make sure sufficient room has been reserved for the air intake and air vent of enterprise-class router to facilitate the heat elimination of the chassis. It is recommended to install the enterprise-class router in the 19-inch standard cabinet. Otherwise, install it on a clean and flat surface. In heated areas, the air conditioning system shall be equipped.
- Make sure the cabinet and workbench is equipped with a good ventilation and cooling system.
- Make sure the cabinet and workbench is steady enough and capable of withstanding the weight of the enterprise-class router and its accessories.
- Make sure the cabinet and workbench is properly grounded.

2.3 Installation Tools and Devices

To enable smooth installation, prepare the following items:

- Installation tools
- Connecting cables
- Related devices

Installation tools include:

- Phillips screwdriver
- Anti-static wrist strap

Connection cables include:

- Power cables
- Configuration cables
- Ethernet cables
- Grounding wires

Related devices include:

- HUB or switch
- Configuration terminal (Mobile phone with App)
- Electric outlet

3 Installing the Enterprise-class Router

3.1 Installation Procedure of Enterprise-class Router

To avoid the damage of enterprise-class router caused by rush or mal-operation during the installation process, install the device as per the following steps shown in Figure 3-1.

Figure 1-11 Device Installation Procedure

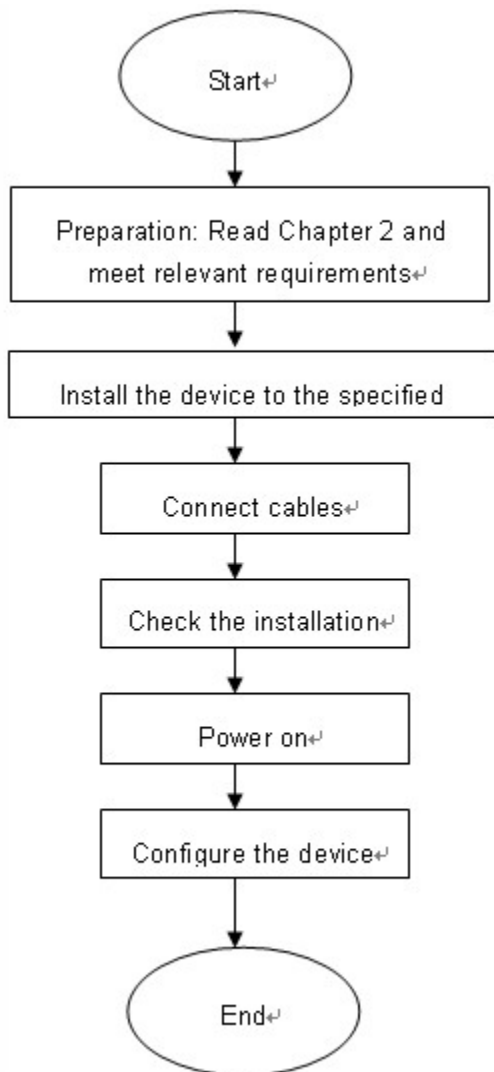

3.2 Mounting the Enterprise-class Router

Mounting the enterprise-class router refers to installing the device to the specified position. Upon completion of installation preparation, fix the enterprise-class router to the specified position. The installation position of enterprise-class router is generally a cabinet or a workbench.

3.2.1 Mounting into a Cabinet

Ruijie enterprise-class router products are designed based on the dimension of a standard cabinet. You can install the device with the enclosed fixing accessories. You can install the device with the enclosed fixing accessories by four M4 screws, length 8mm.

3.2.2 Mounting on a Workbench

In most cases, the user does not have a standard cabinet. Instead, the user can place the device on a clean workbench. Although it is easy and simple, you shall pay attention to the following:

Guarantee the steadiness and good grounding of the workbench;

- Stick the attached plastic pads onto the small holes at the bottom of the enterprise-class router, and reserve a heat elimination room of at least 10 cm around the device. You can install the device with the enclosed fixing accessories by four M4 screws, length 8mm.
- Do not place heavy things on the device.

3.3 Installing Power Cables

The requirements of Ruijie RG-NBR-E series enterprise-class router products on AC power supply are described below (refer to the section of “Product Overview” for detailed parameters):

100–240 V / 50/60 Hz

Make sure your power supply meets the requirement.

The router uses 3-conductor power cables. You are suggested to use a single-phase 3-conductor outlet or a multifunction microcomputer outlet with neutral connector. The neutral point of the power supply shall be securely grounded in the building. In most buildings, the neutral point of a power supply has been grounded during the construction. You need to make sure the power supply is properly grounded.

Install power cables as per the following steps:

- (5) Plug one end of the power cable into the power port on the backpanel of a enterprise-class router, and plug the other end into the AC power supply outlet.
- (6) Check whether the power LED on the front panel of the enterprise-class router lights up or not. The LED indicator will light up if the power supply is properly connected.
- (7) Make sure to ground the equipment by connecting grounding pole using the accessory green-yellow earthing wire.

3.4 EMC Grounding

The grounding required for EMC design includes shielding ground, filter ground, noise and interference suppression, and level reference. All the above constitute the comprehensive grounding requirements. The grounding resistance should be less than 1 ohm. The RG-NBR-E series devices are equipped with a grounding pole at the rear panel, as shown in Figure 3-2.

Figure 1-12 Schematic Diagram of Grounding of the RG-NBR-E Series Devices

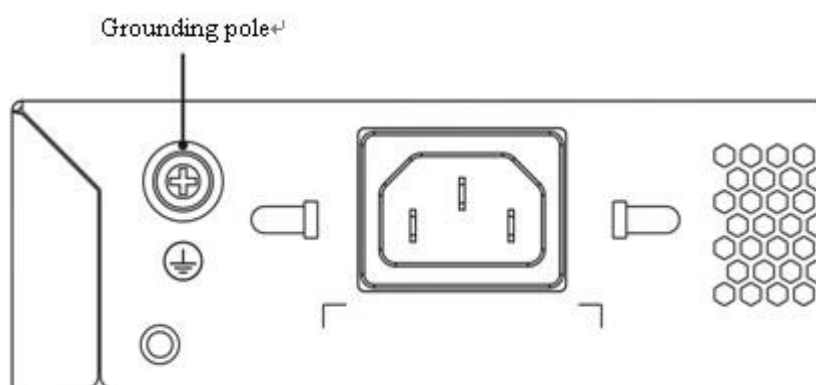

3.5 Checking after the Installation

After completing the mechanical installation of enterprise-class router, perform the following checks before powering on the device:

- If the device is installed in a cabinet, check whether the angle bar for device installation is steady. If the device is installed on the workbench, check whether sufficient room is reserved around the device to ensure heat elimination and whether the workbench is steady.
- Check whether the power supply meets the requirements.
- Check whether the earth wire of device is properly connected.
- Check whether the device is connected correctly to other devices like the configuration terminal.

4 Starting and Configuring the Enterprise-class Router

4.1 Starting a Enterprise-class Router

4.1.1 Building Configuration Environment

When the enterprise-class router is used for the first time, you must configure the enterprise-class router via the console port as follows:

- (8) Connect the serial port of a character terminal or a microcomputer to the console port (or configuration port or control panel port) of a enterprise-class router via a standard RS232 cable.
- (9) Configure the communication parameters of the terminal. If you use a microcomputer, you need to run the terminal emulator like the Hyperterm program provided by Windows operating system. We will describe the operating procedures by taking the example of Hyperterm.
- (10) Run Hyperterm software and establish a new connection, as shown in Figure 4-1;

Figure 1-13 Establish a New Cconnection

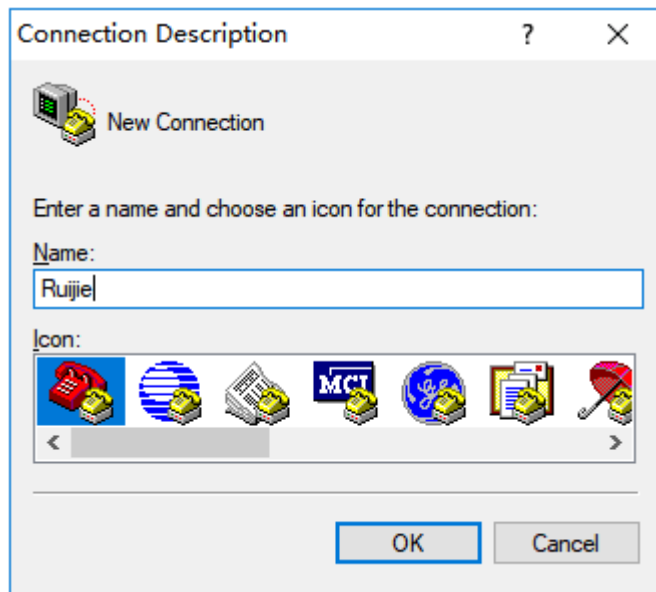

- (11) Select the serial port connecting with the console port of the enterprise-class router, as shown in Figure 4-2;

Figure 1-14 Select the Serial Port of Microcomputer Connecting with the Console Port of Enterprise-class Router

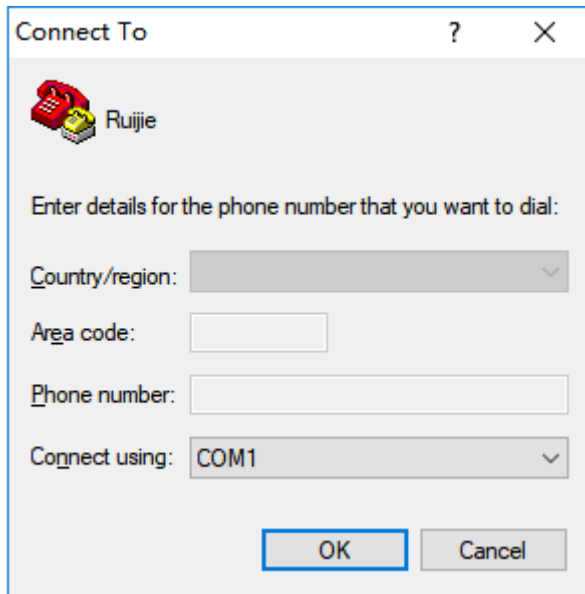

- (12) Configure the communication parameters: 9600 baud rate, 8-bit data bits, 1-bit stop bit, no parity check, and no flow control, as shown in Figure 4-3;

Figure 1-15 Configure the Communication Parameters of the Serial Port

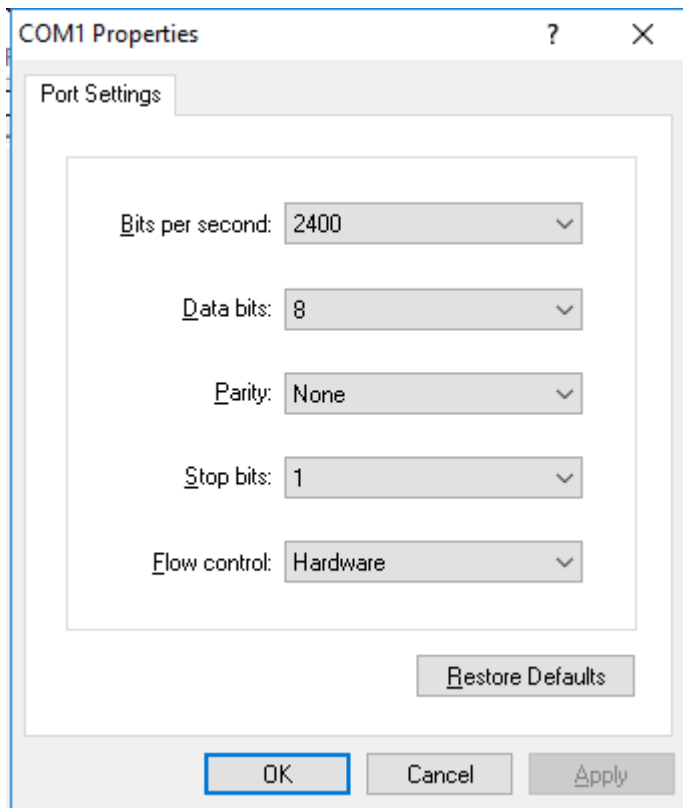

- (13) Choose **File > Attribute > Setting** and select the terminal emulation type of VT100; all as shown in Figure 4-4:

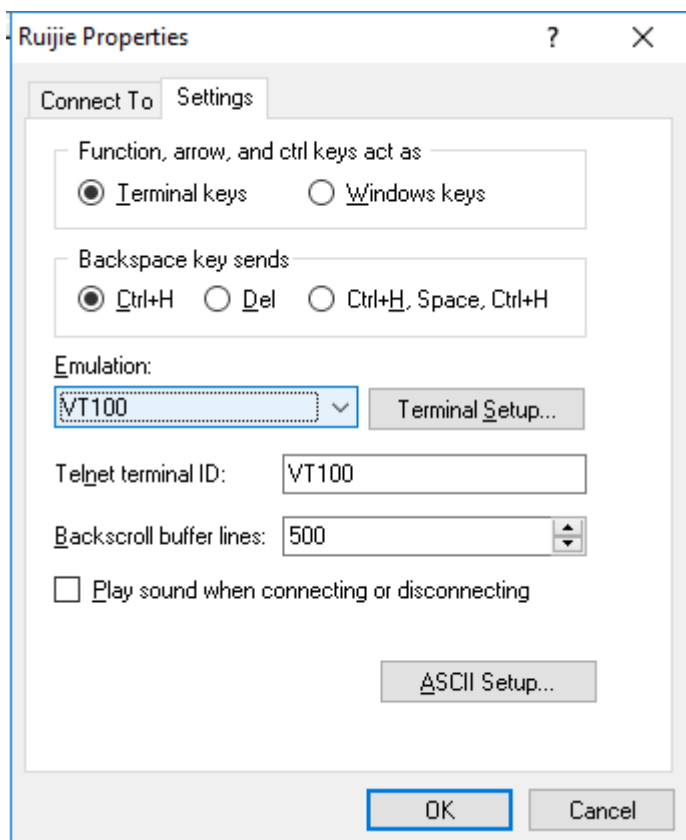
Figure 1-16 Select the Terminal Emulation Type

After building the configuration environment, you can then power on the enterprise-class router.

4.1.2 Powering on the Enterprise-class Router

1. Checks before Power-on

Before power-on, perform the following checks on the enterprise-class router:

- Whether the power cable and the ground wire are properly connected;
- Whether the power voltage is consistent with the requirement of the enterprise-class router.
- Whether the configuration cable is properly connected, and whether the microcomputer or terminal for router configuration is started or configured.

Note

Before powering on the enterprise-class router, be aware of the location of the power switch of the enterprise-class router to timely cut off power supply in case of any accident.

2. Powering on the Enterprise-class Router

- Turn on the power supply switch of the enterprise-class router
- Turn on the power switch of the enterprise-class router and set the power switch to "ON" position.

3. Checks after Power-on

After the enterprise-class router is powered on, check the following items:

- Whether the ventilation system works normally

Checking procedure: After power-on, you can hear the fan working; put your hand nearby the vent hole of enterprise-class router to feel the airflow.

- Whether the LED indicators on the front panel of the enterprise-class router works normally.
Checking procedure: Refer to the section of indicators description about each product in the first chapter "Product Overview".
- Whether the configuration terminal displays normally
Checking procedure: After the enterprise-class router is powered on, the terminal will display the software loading information of the enterprise-class router.

4.1.3 Starting Process

The following information will be displayed when the enterprise-class router is started for the first time:

```
*****
Boot 1.3.12-00503-ga15871f (Build time: Nov 25 2015 - 10:13:23)

DRAM: 2 GiB
NAND:  512 MiB
Flash: 8 MiB
SETMAC: Setmac operation was performed at 2016-01-06 11:03:10 (version: 11.0)
Press Ctrl+C to enter Boot Menu
Creating 1 MTD partitions on "nand0":
0x000000000000-0x000001000000 : "mtd=0"
UBI: attaching mtd2 to ubi0
UBI: physical eraseblock size:  131072 bytes (128 KiB)
UBI: logical eraseblock size:   129024 bytes
UBI: smallest flash I/O unit:   2048
UBI: sub-page size:            512
UBI: VID header offset:        512 (aligned 512)
UBI: data offset:              2048
UBI: attached mtd2 to ubi0
UBI: MTD device name:          "mtd=0"
UBI: MTD device size:          16 MiB
UBI: number of good PEBs:      128
UBI: number of bad PEBs:       0
UBI: max. allowed volumes:     128
UBI: wear-leveling threshold:  4096
UBI: number of internal volumes: 1
UBI: number of user volumes:   1
UBI: available PEBs:           9
UBI: total number of reserved PEBs: 119
UBI: number of PEBs reserved for bad PEB handling: 2
.....
Starting vlan_terminal.elf...           [ OK ]
Starting webservice.elf...
Starting webservice.elf...           [ OK ]
html decompress.
html decompress.                     [ OK ]
Starting php-fpm...create /var/run/php-fpm.pid done...
Starting php-fpm...create /var/run/php-fpm.pid done...           [ OK ]
WARNING: pgstat wait timeout
```

```
Starting Nginx...
Starting Nginx... [ OK ]
Starting newcmd v_tty...
Starting newcmd v_tty... [ OK ]

Press RETURN to get started
WARNING: pgstat wait timeout

Ruijie>
```

After the startup, you can configure the enterprise-class router.

i **Instruction**

- The above startup information is for reference only. The router with different hardware configurations or software versions will display different startup information.
 - In case of using the enterprise-class router for the first time, you are advised to use a configuration function to configure the basic parameters of the enterprise-class router.
-

4.2 Starting the Enterprise-class Router

To use the enterprise-class router, you need to properly configure the enterprise-class router as required. Refer to the relevant configuration guide and command reference for details about enterprise-class router configuration.

5 Troubleshooting

1.2 Power Supply Troubleshooting

Ruijie RG-NBR-E series enterprise-class routers provide a PWR LED on the front panel for indicating whether the power system works normally. Refer to “Product Overview” for the normal state descriptions of LED indicators. If abnormality occurs, perform the following checks:

- Whether the power switch is turned on;
- Whether the power supply of the enterprise-class router is turned on;
- Whether the power cable is properly connected;
- Whether the power supply to the enterprise-class router meets relevant requirements.

 **Note**

Do not plug or pull the power cable when the power switch is already turned on. If everything is ok but the PWR LED still does not light up, contact with a local dealer or technical support personnel.

1.3 Configuration System Troubleshooting

After the enterprise-class router is powered on, the terminal will display the messages described in “Starting and Configuring the Enterprise-class Router” section during the startup process if the system works normally. If the configuration system fails, the terminal may display nothing or illegible characters.

If the terminal displays nothing, perform the following checks:

- Whether the power system works normally;
- Whether the console port cable is properly connected.

If everything is OK and the terminal still displays nothing, the configuration cable may be damaged or the terminal parameters may be improperly configured. Adjust the parameters of the terminal.

If the terminal displays illegible characters, the terminal parameters may be improperly configured. Confirm the following terminal parameters: baud rate being 9600; data bits being 8; parity check being none; stop bit being 1; flow control being none; terminal emulation being VT100.

 **Instruction**

If the parameters of the console port have been modified, the terminal will also display nothing.



Ruijie Networks Co., Ltd.

Building 19, Juyuanzhou Industrial Park, No. 618 Jinshan Road, Cangshan District, Fuzhou, Fujian, China