

Magnetic Gate Lock Installation Manual

TROUBLESHOOTING

Problem:	Possible cause:	Solutions:
Gate does not lock	No power	<ul style="list-style-type: none"> • Check to make sure the wires are secure • Check that the power supply is connected and operating • Make sure the unit is wired correctly
Gate locks, but can be easily forced open	Poor contact between electromagnet and armature plate	<ul style="list-style-type: none"> • Make sure the electromagnet and armature plate are properly aligned • Make sure the contact surfaces of the electromagnet and armature plate are clean and free from rust
	Delay in gate releasing	<ul style="list-style-type: none"> • Incorred voltage setting • A secondary diode was installed across the electromagnet • The electromagnet is fitted with a metal oxide varistor to prevent interference, so do not install a secondary diode

REGULAR MAINTENANCE

- Clean the contact surfaces of the electromagnet or armature plate with a soft cloth and non-abrasive, non-corrosive cleaner.
- Apply a light coat of a silicon lubricant to both contact surfaces and wipe away the excess to prevent rust.
- Check that the armature plate is securely attached to the door, yet can pivot slightly around the armature screw.
- Check that the electromagnet is securely attached to the gate or post.

UL CERTIFICATION

The E-942FC-1300 and E-942FC-600 electromagnetic locks conform to UL/10B "Fire Tests of Door Assemblies" and UL/10C "Positive Pressure Fire Tests of Door Assemblies" for swinging door assemblies. They are also classified in accordance with the Uniform Building Code standard 7-2.

LIFETIME LIMITED WARRANTY: This SECO-LARM product is warranted against defects in material and workmanship while used in normal service for the lifetime of the product. SECO-LARM's obligation is limited to the repair or replacement of any defective part if the unit is returned, transportation prepaid, to SECO-LARM. Under no circumstances will SECO-LARM be responsible for any costs or charges for removal, installation, or reinstallation.

This Warranty is void if damage is caused by or attributed to acts of God, physical or electrical misuse or abuse, neglect, repair, or alteration, improper or abnormal usage, or faulty installation, or if for any other reason SECO-LARM determines that such equipment is not operating properly as a result of causes other than defects in material and workmanship.

The sole obligation of SECO-LARM, and the purchaser's exclusive remedy, shall be limited to repair or replacement only, at SECO-LARM's option. In no event shall SECO-LARM be liable for any special, collateral, incidental, or consequential personal or property damages of any kind to the purchaser or anyone else. This lifetime limited warranty is for products sold and installed in the United States and Canada. For all other countries the warranty is 1 (one) year.

NOTICE

Copyright © 2011 SECO-LARM U.S.A., Inc. All rights reserved. This material may not be reproduced or copied, in whole or in part, without the written permission of SECO-LARM. This material is subject to change without notice. SECO-LARM is not responsible for misprints.

SECO-LARM U.S.A., Inc.

16842 Millikan Avenue, Irvine, CA 92606 Website: www.seco-larm.com
 Tel: 800-662-0800 / 949-261-2999 Fax: 949-261-7326 E-mail: sales@seco-larm.com

Installation Manual

SECO-LARM®

E-942FC-1300 E-942FC-600 Electromagnetic Gate Locks



- For use with nearly all types of outdoor sliding and swinging electric gates.
 - E-942FC-1300 — 1,200 pounds (591kg).
 - E-942FC-600 — 600 pounds (271kg).
- Can be mounted horizontally or vertically.
- Housing dimensions:
 - E-942FC-1300 — 8" x 2 1/2" x 1 1/2" (203 x 63 x 38 mm).
 - E-942FC-600 — 8" x 1 1/16" x 1 9/16" (203 x 43 x 40 mm).
- Armature plate dimensions:
 - E-942FC-1300 — 7 1/4" x 2 7/8" x 5/8" (185 x 61 x 16 mm).
 - E-942FC-600 — 6 1/4" x 1 5/8" x 9/16" (159 x 41 x 14 mm).
- Power — 12VDC or 24VDC, with current draw of 500mA at 12VDC (250mA @ 24VDC).
- Cable — 6.5' (2 meters), with dual-threaded conduit connector. (3' [90cm] for E-942FC-600)



MOUNTING

- Determine type of gate:
 - Single-swing gate** (fig. 2) — Gate swings on one end, and comes to rest on a fixed gate post when closed. In this case, a typical installation has the electromagnet fixed to the gate post, and the armature connected to the free end of the gate with a Z-bracketed one gate, and the armature is fixed to the free end of the other via a Z-bracket. **IMPORTANT:**
 - A cover piece should be added to the Z-bracket to cover the electromagnet. This will help prevent unauthorized users from prying the armature and the electromagnet apart.
 - Because of the cover piece, it is important to coordinate the swing of the gates to prevent the electromagnet from catching on the cover piece. In this case, the gate with the armature should open before the gate with the electromagnet.
 - Double-swing gate** (fig. 3) — Two gates swing in the same direction when activated. The electromagnet is fixed to the free end of one gate, and the armature is fixed to the free end of the other via a Z-bracket. **IMPORTANT:**
 - A cover piece should be added to the Z-bracket to cover the electromagnet. This will help prevent unauthorized users from prying the armature and the electromagnet apart.
 - Because of the cover piece, it is important to coordinate the swing of the gates to prevent the electromagnet from catching on the cover piece. In this case, the gate with the armature should open before the gate with the electromagnet.
 - Sliding gate** (fig. 4) — The gate slides instead of swings away from a fixed gate post. In this case, use L-brackets to mount the electromagnet and the armature perpendicular to each other.
- Mount the electromagnet (fig. 5) — In most cases, the position of the electromagnet will determine the location of the armature plate. Make sure there is space to run the cable.

Note: For hollow door headers or gate posts using blind nuts (see figure 6):

 - Tape the template to the appropriate location.
 - Drill four (E-942FC-1300) or two (E-942FC-600) 9.5mm (3/8") holes, one for each short hex screw. **IMPORTANT:** The holes must be 9.5mm (3/8"). No smaller, no larger.
 - Insert a blind nut in one of the 9.5mm (3/8") holes.
 - Put the washer on the M6x30 screw. Then put the hex tool on the screw. Then turn the screw by hand into the blind nut.
 - Use a wrench or vice-grip to tightly hold the hex tool. Then use the included Allen wrench to slowly tighten the screw until it does not turn any further. This compresses the blind nut so that it remains permanently fixed in the hole.
 - Remove the screw.
 - Repeat steps 3) through 6) for the other blind nuts.
 - Push hex screws into each of the screw holes in the electromagnet. Use the Allen wrench to tighten the screws into the blind nuts.

- C. Mount the armature (fig. 5) — Once the electromagnet is mounted, determine the correct position of the armature. Use the appropriate L-bracket or Z-bracket to position the armature so that it will lay against the electromagnet when activated. However, leave a slight gap between the two so that the armature does not slam against the electromagnet when the gate is closed.
- Put one rubber washer between two steel washers, and place them over the armature screw between the armature and the bracket. This will allow the armature to pivot slightly around the armature screw in order to compensate for gate misalignment.
 - Make sure the guide pins are inserted into guide holes to prevent the armature from spinning.
 - Tighten the sexnut enough so the armature can withstand the force of someone attempting to pry the gate open while the electromagnet is engaged.
 - Do not tighten the armature against the bracket. The armature must be able to pivot around the armature screw.
- D. Cover the installation — Use a steel box to make the installation more attractive as well as prevent unauthorized users from prying the armature and electromagnet apart when engaged.

E. Run the wires — The goal is to keep as little of the wires exposed as possible.

- Run the wires into an out-of-sight location as close as possible to the electromagnet. Run them inside hollow gate posts if possible.
 - Use standard armored cable to prevent the wires from being cut between the electromagnet and the out-of-sight location.
- F. Connect the wires:

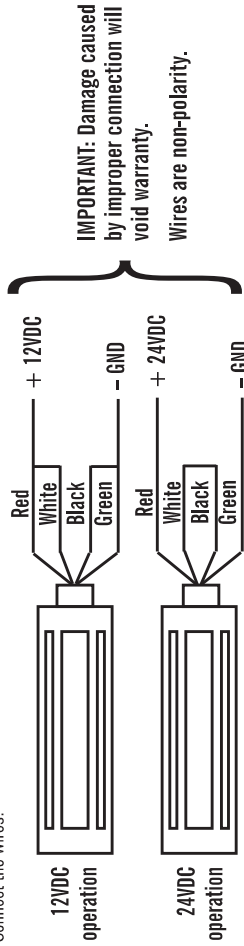

G. Test the unit.

H. Insert the tamper caps into the mounting screw access holes of the electromagnet. This should be the last step, as once the tamper caps are in place, they are difficult to remove.

FIG. 1 - Parts

List of Parts

- 1 x Electromagnet
- 1 x Armature plate
- 1 x Armature screw
- 3 x Large steel washers*
- 2 x Rubber washers*
- 1 x Sexnut bolt
- 4 x Mounting screws*
- 4 x Small washers*
- 4 x Tamper caps*
- 2 x Guide pins
- 1 x Hex key (Allen wrench)
- 4 x Blind nuts**
- 1 x Blind nut assembly set (M6x30 screw, blind nut, washer)
- 1 x Door spacer (tube)*

* Note — E-942FC-600

comes with 2 steel washers,
1 rubber washer, 2 mounting screws, no small washers,
2 tamper caps, 2 blind nuts, and no door spacer. Also includes a black collar for the armature screw.

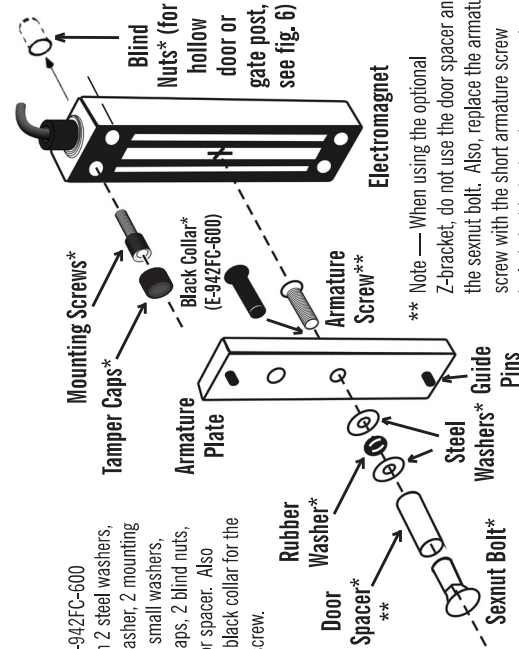

FIG. 2 - Installation on a single-swing gate

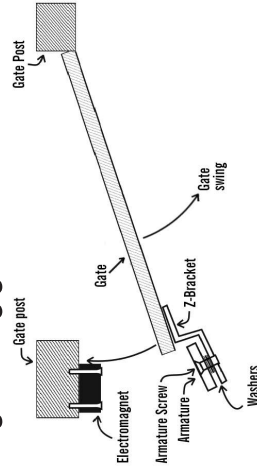

FIG. 3 - Installation on a double-swing gate

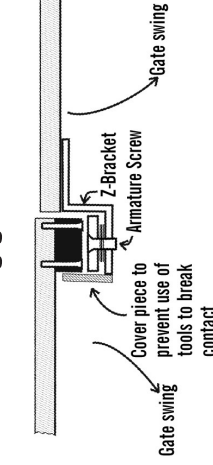

FIG. 4 - Installation on a sliding gate

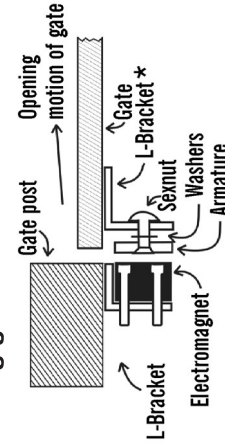

FIG. 5 - Basic Installation

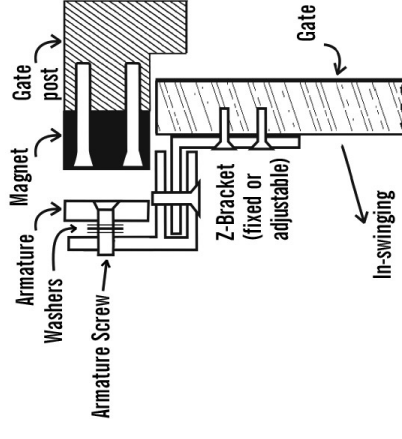
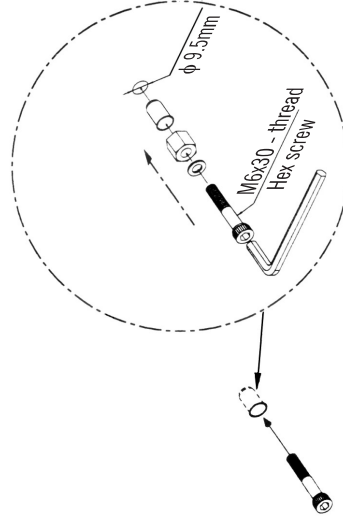

FIG. 6: Mounting the blind nuts in a hollow door or gate post



Allen wrench must be firmly seated while turning hex screw.

Hold with wrench or vice grip while turning hex screw.

Blind nut - Press into 9.5mm hole as shown.

ACCESSORIES

- E-942F-1300/ZQ - "Z" bracket for E-942FC-1300
- E-942F-1300/L - "L" bracket set for E-942FC-1300
- E-942F-600/Z - "Z" bracket for E-942FC-600
- E-942F-600/L - "L" bracket set for E-942FC-600

